



PROFESSIONAL 1000 TRADITIONAL 1000

Use and Installation Instructions

This appliance must be installed in accordance with the regulations in force and only used in a well ventilated space.

The data badge is fitted on the rear panel. The model/serial number can also be found on a badge located below the left-hand oven door beneath the door seal.

Read these instructions before installing or using the appliance and retain them for future reference.

These instructions are only valid for the countries whose symbols appear in the manual and on the serial number plate.

CONTENTS

PAGE

Introduction	3
For Your Safety	4
Oven Timer Operation	6
Hotplate	12
Griddle	14
Some recipe ideas for your griddle	15
Twin Grill	16
Fan Oven	17
Conventional Oven	19
Oven Cooking Chart	20
The “Slow Cook” Setting	22
Care and Cleaning	23
Something wrong with your Cooker?	25
Installation Instructions	27
Guarantee Information	35
Service Information	36

INTRODUCTION

To help you make the best use of your cooker, PLEASE READ THIS BOOKLET CAREFULLY.

Your new cooker is guaranteed and will give lasting service. The guarantee is only applicable if the cooker has been installed in accordance with the Installation Instructions.

The cooker is designed specifically for domestic use and responsibility will not be accepted for use in any other installation.

When first using the cooker ensure that the room is well ventilated (e.g. open a window or use an extractor fan) and that persons who may be sensitive to the odour avoid any fumes. It is suggested that any pets be removed from the room until the smell has ceased. This odour is due to any temporary finish and also any moisture absorbed by the insulation.

Our policy is one of continual improvement in design and development, therefore strict accuracy of illustrations and descriptions cannot be guaranteed.



This appliance conforms to the following EEC directives:

Gas Appliances

- 90/396/EEC

Low Voltage Equipment

- 2006/95/EEC

- 93/68/EEC

Electromagnetic Compatibility;

- 89/336/EEC

- 92/31/EEC

- 93/68/EEC

FOR YOUR SAFETY

Please read the precautions below before using your cooker.

ALWAYS . . .

- ALWAYS make sure you understand the controls before using the cooker.
- ALWAYS check that all controls on the cooker are turned off after use.
- ALWAYS stand back when opening an oven door to allow heat to disperse.
- ALWAYS use dry, good quality oven gloves when removing items from the ovens.
- ALWAYS take care when removing items from the top oven/grill when the main oven is on, as the contents may be hot.
- ALWAYS keep the oven and grill doors closed when the cooker is not in use.
- ALWAYS place pans centrally over the hotplate burners and position them so that the handles cannot accidentally be caught or knocked or become heated by other burners.
- ALWAYS keep the cooker clean, as a build up of grease or fat from cooking can cause a fire.
- ALWAYS allow the cooker to cool before cleaning.
- ALWAYS follow the basic principles of food handling and hygiene to prevent the possibility of bacterial growth.
- ALWAYS keep ventilation slots clear of obstructions.
- ALWAYS turn off the electricity supply before cleaning or replacing an oven lamp.
- ALWAYS refer servicing to CORGI registered appliance service engineers.
- ALWAYS ACCESSIBLE PARTS MAY BECOME HOT WHEN THE GRILL IS USED. YOUNG CHILDREN SHOULD BE KEPT AWAY.
- ALWAYS Children should be supervised to ensure that they do not play with the appliance
- ALWAYS During use the appliance becomes hot. Care should be taken to avoid touching heating elements inside the oven

FOR YOUR SAFETY

NEVER . . .

- NEVER leave children unsupervised where the cooker is installed as all surfaces will get hot during and after use.
- NEVER allow anyone to sit or stand on any part of the cooker.
- NEVER store items that children may attempt to reach above the cooker.
- NEVER heat up unopened food containers as pressure can build up causing the container to burst.
- NEVER store chemicals, food stuffs, pressurised containers in or on the cooker, or in cabinets immediately above or next to the cooker.
- NEVER fill a deep fat frying pan more than 1/3 full of oil, and never use a lid. **DO NOT LEAVE UNATTENDED WHILE COOKING.**
- NEVER place flammable or plastic items on or near the hotplate.
- NEVER use proprietary spillage collectors on the hotplate.
- NEVER use the cooker as a room heater.
- NEVER dry clothes or place other items over or near to the hotplate or oven/grill doors.
- NEVER wear garments with long flowing sleeves whilst cooking.
- NEVER operate the grill with the grill doors closed. This may cause overheating of your cooker.
- NEVER line the shelves, floor or sides of the oven or grill with aluminium foil as over heating and damage can result.
- NEVER use steam cleaners.
- NEVER touch the heating elements inside the oven or grill even when off.

NOTE: The use of a gas cooking appliance results in the production of heat and moisture in the room in which it is installed. Always ensure that the kitchen is well ventilated; keep natural ventilation holes open or install a mechanical ventilation device (mechanical extractor hood).

In particular when using the grill or more than one hotplate burner, open a window if a mechanical ventilation device is not operating.

! The appliance should not be operated by people (including children) with reduced physical, sensory or mental capacities, by inexperienced individuals or by anyone who is not familiar with the product. These individuals should, at the very least, be supervised by someone who assumes responsibility for their safety or receive preliminary instructions relating to the operation of the appliance.

OVEN TIMER OPERATION

The oven timer (only ventilated Oven) offers you the following features:

1. Time of Day
2. Automatic Cooking
3. Minute Minder

AUTOMATIC COOKING

The main oven can be controlled automatically.

GUIDANCE ON AUTOMATIC COOKING

1. Select foods which will take the same time to cook.
2. Set the oven timer so that the food has just finished or is just about to finish cooking on your return to the oven. This will ensure the food has not cooled down and does not require reheating before serving.
3. Food should be as cold as possible when it goes into the oven, ideally straight from the refrigerator. Frozen meat and poultry should be thawed thoroughly before it is put in the oven.
4. Warm food should never be placed in the oven if there is to be a delay period. Stews prepared by frying the meat and vegetables should be cooked as soon as possible.
5. Dishes containing left-over cooked poultry or meat, for example Shepherds Pie, should not be cooked automatically if there is to be a delay period.
6. Stews and joints should be cooked by the long slow method, so that the delay period is kept to a minimum.
7. On warm days, to prevent harmful bacterial growth in certain foods (ie poultry, joints, etc) the delayed start should be kept to a minimum.
8. Wine or beer may ferment and cream may curdle during the delay period, so it is best to add these ingredients just before serving.
9. Foods which discolour should be protected by coating in fat or tossing in water to which lemon juice has been added, prior to placing food in the oven.
10. Dishes containing liquid should not be filled too full to prevent boiling over.
11. Food should be well sealed (but not airtight) in a container to prevent the loss of liquid during cooking. Aluminium foil gives a good seal.
12. Ensure food is cooked thoroughly before serving.

OVEN TIMER OPERATION



CLOCKFACE

The timer incorporates a 24 hour clock.

Ensure the correct time of day is always set, before using your cooker.

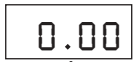

SYMBOLS

A 'bell' symbol will light up when you select a Minute Minder Period and will remain lit for the period set.

At the end of the Minute Minder Period, the timer will emit an audible tone and the 'bell' symbol will disappear.

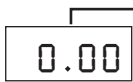

The 'cookpot' symbol will light up either:-

- When the timer is in manual mode, or
- During the actual Cook Period.



'AUTO' will light up:-

- When the timer is first turned on it will flash. It will go out when a time of day is set or when the timer is set to manual.

The 'AUTO' symbol will flash at the end of an Auto Cooking programme to indicate that the programme has finished.



(When the 'AUTO' symbol is flashing, to return the oven to Manual operation, turn the oven controls off, ensure that the correct time of day is set, and press the "Manual" button - The 'AUTO' symbol will go out).

TIMER FUNCTION BUTTONS

Minute Minder Button

Here you can set a time period of up to 23 hours 59 minutes, that will count down. When it reaches zero, the timer will emit an audible tone.

For Example: If you set 20 minutes, the audible tone will occur 20 minutes later.

AUTO COOKING PROGRAMME

Cook Period Button

Cook Period is the actual length of time for which, the timer will switch the oven(s) on as part of an "Auto Cooking" programme. (e.g. If you set 2 hours, the food will be cooked for 2 hours).

End Time Button

The time of day at which you want an "Auto Cooking" programme to end.

For Example: If you set a "Cook Period" for 2 hours, and "End Time" of 11:00. The timer will switch the oven(s) on at 9:00 and turn the oven(s) off at 11:00. You will hear a audible tone at 11:00, to indicate that the Auto Cooking Programme has finished.

Notes:

- When setting an Auto Cooking programme you will need to set the oven control(s) to the required temperature(s) when you set the timer.
- If an Auto Cooking programme has been set the oven(s) will only operate during the pre-programmed time.

Manual Button

Needs to be pressed to cancel an Auto Cooking programme and return the oven(s) to Manual operation.

"+" and "-" Buttons

Used to adjust the various timer function settings.

OVEN TIMER OPERATION

SETTING THE TIME OF DAY

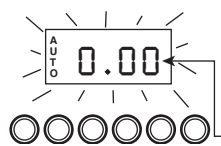

Step 1 Make sure all oven controls are turned Off.

Step 2 Check the electricity supply to the cooker is turned on.

Step 3 When switched on the display will show 0.00 and the Auto symbol, flashing intermittently.

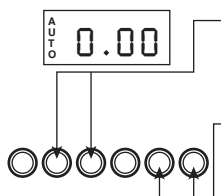

Step 4 Press & hold in both the Cook Period & End Time buttons together.

Step 5 With the Cook Period & End Time buttons still held in, press either the "+" or "-" buttons to set the correct time of day.

Step 6 Release all the buttons simultaneously. THE TIME OF DAY IS NOW SET.

To change the time of day repeat Steps 4, 5 & 6 above.

Note: You cannot adjust the time of day if the timer has been set for an Auto Cooking Programme.

SETTING THE MINUTE MINDER

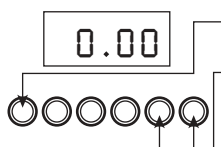

Step 1 Ensure the time of day is set correctly.

Step 2 Press and hold the Minute Minder button.

Step 3 With the Minute Minder button held in, set the required Minute Minder period using the "+" and "-" buttons. A 'bell' symbol will light up.

Release all buttons and the timer display will revert back to the time of day. The 'bell' symbol will remain lit to signify that a Minute Minder period has been set.

At the end of the set time an audible tone will be heard, and the 'bell' symbol will disappear.

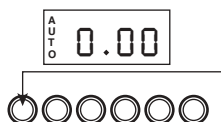

Step 4 To cancel the audible tone press the Minute Minder button.

Note 1 When the Minute Minder has been set, the time remaining can be checked at any time by simply pressing the Minute Minder button.

Note 2 If necessary the Minute Minder can be cancelled before the tone sounds by pressing and holding the Minute Minder button and then at the same time pressing the "-" button until 0.00 appears in the display window.

OVEN TIMER OPERATION

AUTO COOKING PROGRAMMES

There are two Auto Cooking programmes that can be selected using your timer:-

- (a) To set the timer to switch the oven(s) On and Off Automatically
- (b) To set timer to switch on immediately and OFF automatically after a set cook period.

a) TO SET THE TIMER TO SWITCH THE OVEN(S) ON AND OFF AUTOMATICALLY

This allows you to cook at a specified time for a chosen period before the oven switches off Automatically.

Step 1 Check that the correct time of day is set, if not follow instructions for setting the time of day.

Step 2 Place food onto the correct shelf position in the oven and close the oven door(s).

 **Step 3** Press and hold in the Cook Period button. The display will read 0.00 with the 'cookpot' symbol lit.

 **Step 4** With the Cook Period button still held in, set the required Cook Period using the "+" and "-" buttons.

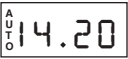
 Release the buttons and the timer display will revert to the time of day with the 'Auto' symbol and 'cookpot' symbol lit.

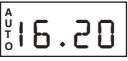

 **Step 5** Press and hold in the End Time button. The display will read the earliest possible end time for the Cook Period that you have set above. The 'Auto' symbol and 'cookpot' symbol will be lit.

 **Step 6** With the End Time button still held in, use the "+" and "-" buttons to set the 'End Time' (i.e. The time you require the oven to switch off). Release all the buttons and the timer will revert back to the time of day.

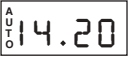
 The 'Auto' symbol will remain lit to signify that an Auto Cooking Programme has been set. The 'cookpot' symbol will go out.



Step 7 Turn the oven control(s) to the required temperature, and if necessary select the appropriate oven function.

At the end of the Automatic Cook Period the Auto Symbol will flash and an intermittent beeping sound will be heard.

The audible tone will continue unless cancelled.

The 'Auto' symbol will continue to flash until the timer is returned to Manual operation (see below).

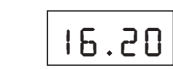
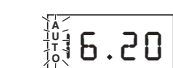

Step 8 Press the Manual button, the audible tone will be cancelled and the oven(s) will be returned to Manual.

Step 9 Turn the oven control(s) to the OFF position.

OVEN TIMER OPERATION

Note 1 When cooking automatically the Cook Period can be checked at any time by simply pressing the Cook Period button.

Note 2 When cooking automatically the End Time can be checked at any time by simply pressing the End Time button.

b) TO SET TIMER TO SWITCH ON IMMEDIATELY AND OFF AUTOMATICALLY AFTER A SET COOK PERIOD

Step 1 Check that the correct time of day is set, if not follow instructions for setting the time of day.

Step 2 Place food onto the correct shelf position in the oven and close the oven door(s).

Step 3 Turn the oven control(s) to the required temperature, and if necessary select the appropriate oven function.

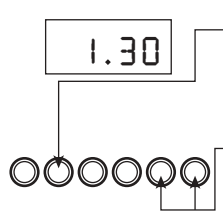

Step 4 Press & hold in the Cook Period button, the display will read 0.00 and the 'cookpot' symbol will light up. With the Cook Period button still held in set the required Cook Period using the "+" and "-" buttons. Example: 1hr 30 minutes (as shown).

Step 5 Release all buttons.

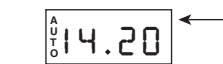

The timer display will revert to the time of day with the 'Auto' symbol lit & 'cookpot' symbol remaining lit.



NOTE: The Cookpot symbol disappears

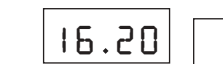

At the end of the Cook Period the 'Auto' symbol will flash and an intermittent audible tone will be heard. The audible tone will continue until cancelled. The 'Auto' symbol will continue to flash until the timer is returned to Manual operation (see below).

Step 6 Press the Manual button. The audible tone will be cancelled and the oven(s) will be returned to Manual.



Step 7 Turn the oven control(s) to the OFF position.

OVEN TIMER OPERATION

TO CANCEL AN AUTO COOKING PROGRAMME BEFORE THE COOK PERIOD HAS FINISHED.

Step 1 Turn the oven control to the OFF position.

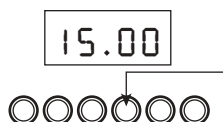

Step 2 Press the Manual button to return the oven to "Manual" operation. The 'Auto' symbol will go out.

Note 1 When cooking automatically the Cook Period can be checked at any time by simply pressing the Cook Period button.

OTHER NOTES ON TIMER OPERATION

1. When cooking Automatically the Cook Period can be checked at any time simply by pressing the Cook Period button.
2. When cooking Automatically the End Time can be checked at any time by simply pressing the End Time button.
3. Having set a Cook Period and End Time an electronic device stores the information. The device within the timer will switch the oven(s) on and off at the required times.
4. When setting an Auto Cooking Programme and a mistake is made, to clear:-
 - (a) Press & release the Manual button.
 - (b) Start the sequence again.
5. If at any time the display shows three flashing zero's 0.00 and 'Auto', it is likely that the electricity supply to the oven has been interrupted. Reset the timer to the correct time of day. ***Food in the oven may, therefore, not have been cooked, before serving check food is thoroughly heated and completely cooked.***
6. To set each function always press and hold the required function button and at the same time press "+" or "-" buttons.

HOTPLATE

The hotplate has one dual control wok burner, one large high speed burner, three normal simmering burners and one small simmering burner. The dual control wok burner consists of a smaller inner and a larger outer burner that can operate either together or separately. Use of the two burners together with large pans on maximum setting gives a very high input and reduces cooking times with respect to conventional burners. Use of the two burners together provides a more uniform distribution of heat on the bottom of the pan. Cookware of all sizes can be used above the dual control wok burner. For small pans it is recommended that only the inner burner is used.

The knob situated below the symbol  on the fascia panel operates the outer burner.

The knob situated below the symbol  on the fascia panel operates the inner burner.

The two normal simmering burners on the right hand side of the hotplate are oval in form and can be turned through 90°. This makes the hotplate more flexible in how it can be used.

For cooking fish or heating oval cookware use the two burners with their longest sides at 90° to the front of the hotplate.

When using the griddle or for heating rectangular, square or large cookware use the two burners with their longest sides parallel to the front of the hotplate.

For medium size cookware use any of the two burners in any orientation.

All pans should be placed centrally over the burners.

TO USE THE HOTPLATE

1. Press the ignition button and then push in and turn the control knob of the chosen burner anti-clockwise to the large flame symbol. Continue to press the ignition button until the spark lights the gas. When operating the dual control burner there is a separate control knob for the inner and outer burners.
2. Turn the control knob anti-clockwise to the desired setting. Only turn the control knob between the large flame symbol and the small flame symbol for adjusting the setting.
3. To turn off, turn the control knob fully clockwise to the **O** position.

DO NOT use mis-shapen pans which may be unstable.

DO NOT use round base woks directly on the pan supports.

Each burner is fitted with a spark ignitor for lighting the gas. To ensure rapid lighting of the burners every time they are used, the ignitors must be kept **clean and dry**. Remove any food spillage or cleaning materials from the ignitor using a small nylon brush such as a tooth brush. Access to the ignitor can be achieved by lifting off the loose burner parts carefully when the burners are cool.

In the event of the burner flames being accidentally extinguished, turn off the burner controls and do not attempt to re-ignite the burners for at least 1 minute.

If aluminium based pans are used, a silvery deposit may appear on the top edge of the pan support fingers. See 'Care and Cleaning' section for cleaning information.

Models with Hob Gas Burner Safety Devices to Prevent Leaks (only available on certain models)

These models can be identified by the presence of the device itself.

! Since the hob burners are equipped with a safety device, you must hold the control knob in for about 3 seconds after the burner has been lighted to allow the gas to pass until the safety thermocouple has heated.

HOTPLATE

For the hotplate to work in the most efficient way possible and in order to save on the amount of gas consumed, it is recommended that only pans which have a lid and a flat base are used. They should also be suited to the size of the hotplate.

Hotplate	∅ Cookware diameter (cm)
Rear left	24 - 26
Front left	16 - 22
Centre rear	10 - 14
Front right	16 - 22
Rear right	16 - 22
Centre front (DCDR internal)	10 - 14
Centre front (DCDR external)	26 - 28

! Make sure the pans do not overlap the edges of the hob while it is being used.

SAFETY REQUIREMENTS FOR DEEP FAT FRYING

1. Never fill chip pans more than one third full with oil or fat.
2. Never leave oil or fat unattended during the heating or cooling period.
3. Never heat fat or fry with a lid on the pan.
4. Always dry food thoroughly before frying, and lower it slowly into the hot oil or fat. Frozen foods in particular will cause frothing and spitting if added too quickly.
5. Always keep the outside of the pan clean and free from streaks of oil or fat.

HOW TO DEAL WITH A FAT FIRE

1. **Do not** move the pan.
2. Turn off the hotplate burners.
3. Smother the flames with a fire blanket or damp cloth to extinguish the fire. **Do not** use water or a fire extinguisher as the force of it may spread the burning fat or oil over the edge of the pan.
4. Leave the pan for at least 60 minutes before moving it.

GRIDDLE

A non-stick griddle is supplied for use over the two burners on the right hand side of the hob. The griddle is made of cast iron and the surface is covered with a special nonstick finish. To protect the non-stick coating never use metal cooking utensils as they may scratch the surface. Wooden or heat resistant plastic utensils may be used. Do not use saucepans on the griddle plate.

UNDER NO CIRCUMSTANCES MUST THE GRIDDLE PLATE BE USED OVER ANY OTHER HOTPLATE BURNERS.

USE OF THE GRIDDLE

The griddle may be used with either or both of the burners on, depending on the food being cooked. The griddle can be positioned with the ridged portion at the front or at the rear.

1. Secure the griddle above the two simmer burners, on the right hand side of the hob, making sure that the support feet are located correctly on the pan support fingers.
2. Press the ignition button and then push in and turn the control knob(s) of the burners anticlockwise to the large flame symbol. Continue to press the ignition button until the spark lights the gas. Preheat the griddle plate for approximately four minutes.
3. Place the food directly on the griddle plate. However when cooking drier foods eg. drop scones the griddle plate can be lightly greased.
4. The controls can be left at high for the sealing of foods or turned down to a lower heat setting depending on what food is being cooked. NB. A gentle heat is all that is required for the majority of griddling. Once the griddle plate is up to temperature it maintains the cooking temperature on a medium/low setting.
5. Cook the food for the required time, which will depend on the type of food being cooked.
6. To turn off, push in and turn the control knob(s) fully clockwise to the O position.
7. Allow the griddle plate to cool before cleaning.

In the event of the burner flames being accidentally extinguished, turn off the burner controls and do not attempt to re-ignite the burners for at least 1 minute.

- SOME RECIPE IDEAS FOR YOUR GRIDDLE -

DROPPED SCONES

4oz (100g) plain flour
1/4 tsp salt
1 level tsp (5ml) cream of tartar
1/2 level tsp (2.5ml) bicarbonate of soda
1 egg
1oz (25g) caster sugar
1/4 pint (150ml) milk
1/2oz (10g) margarine

METHOD

1. Rub the fat into the flour.
2. Beat in the remaining ingredients.
3. When a smooth batter has been obtained, drop spoonfuls on to the pre-heated griddle plate.
4. Turn each scone when bubbles start to burst on the upper side.
5. Cook on the reverse side until light brown and the scone, when split, is dried through.
6. Allow approx. 3 minutes for the first side and 2 minutes for the second.
7. Place inside a clean folded towel laid over a cooling rack.
8. When cool, butter and serve.

WELSH CAKES

6oz (175g) plain flour
1/2 level tsp (2.5ml) salt
1/4oz (5g) baking powder
2oz (50g) margarine
2oz (50g) sugar
2oz (50g) currant or sultanas
1/4 tsp grated nutmeg
1 egg
a little milk

METHOD

1. Sieve the flour and salt into a bowl.
2. Rub in the fat.
3. Add the dry ingredients.
4. Beat the egg and mix to a soft dough adding a little milk to obtain a soft consistency.
5. Roll out 1/4" (5mm) thickness.
6. Cut out with a 2" (50mm) plain cutter.
7. Cook on the pre-heated griddle for about 6 minutes each side.
8. They may be eaten hot or cold and should be split and buttered.

POTATO CAKES

8oz (225g) warm creamed potatoes
2oz (50g) plain flour
1/2 (2.5ml) salt
pepper to taste
2 tsp (10ml) milk

METHOD

1. Mix all the ingredients together.
2. Knead lightly.
3. Roll out thinly and cut with a pastry cutter to suit requirements.
4. Cook on a pre-heated griddle for 3-4 minutes on each side.

TWIN GRILL

**CAUTION - ACCESSIBLE PARTS MAY BECOME HOT WHEN THE GRILL IS USED.
YOUNG CHILDREN SHOULD BE KEPT AWAY.**

GRILLING SHOULD NEVER BE UNDERTAKEN WITH THE GRILL DOOR CLOSED.

The grill control is designed to provide variable heat control of either the full width of the grill or just the grill half. Turning the control knob clockwise will switch on the full width and turning anticlockwise will switch on just the grill half.

A gentle flow of air will be blown from underneath the control panel when the grill is in use.

If the fan fails to blow air beneath the control panel when the grill is in use, you should contact your service engineer immediately (see back page).

Using the grill pan kit

The grill pan handle is detachable from the pan to facilitate cleaning and storage. Fix the pan handle securely before use:

1. Fit the handle to the grill pan so the external 'hooks' embrace the that edge of the pan (fig. 1)
2. Make sure that the middle part of the handle fits exactly the protruding support of the pan (fig .2) and holds the pan from the bottom.

The food must be placed on the rack in the grill pan.

Position the grill pan on top of the oven rack. The best results are achieved by placing the oven rack on the uppermost shelves. Pouring a little water into the grill pan will make the collection of grease particles more efficient and prevent the formation of smoke.

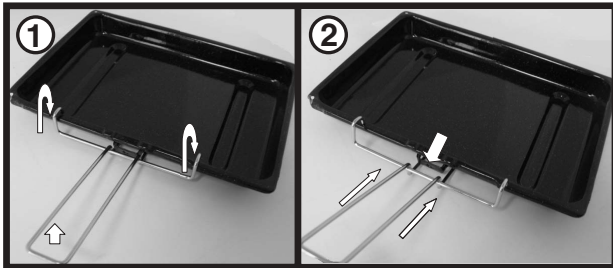

TO USE THE GRILL

2. Open the top grill door
2. Turn the grill control knob clockwise to **4** for full width grilling or anticlockwise for half width grilling.
3. Slide the grill pan toward the back of the grill compartment until it stops.
4. Leave the control at **4** for toast and for sealing and for fast cooking of foods. For thicker foods requiring longer cooking, turn the control to a lower setting after sealing on both sides at **4**.

Grilling can be started from cold but for best results preheat for approximately 2 minutes.

DO NOT cover the grill pan or grid with aluminium foil as this can hold fat, intensify the heat and create a fire hazard.

FAN OVEN

The heating of the oven is achieved by turning the control knob clockwise to the required temperature as recommended in the temperature charts. The pilot light will immediately come on and will automatically go off and on during cooking as the oven thermostat maintains the correct temperature.

It should be noted that at the end of a cooking period there may be a momentary puff of steam when the oven door is opened, this will disperse in a few seconds and is a perfectly normal characteristic of an oven with a good seal.

Since a fan oven heats up more quickly and generally cooks food at a lower temperature than a conventional oven, pre-heating the oven is often unnecessary. However, foods such as bread, scones, Yorkshire pudding do often benefit from being placed in a preheated oven.

The charts on pages 20 and 21 are a guide only, giving approximate cooking temperatures and times. To suit personal taste and requirements, it may be necessary to increase or decrease temperatures by 10°C.

Unless otherwise indicated in the charts, food is placed in a cold oven ie. without preheating.

If food is placed in an already hot oven, the suggested cooking time should be reduced, depending on the type and quantity of food being cooked.

OVEN POSITIONS

Since the distribution of heat in the fan oven is very even, most foods will cook satisfactorily on any shelf position, but the shelves should be evenly spaced.

To ensure even circulation do not use meat pans larger than 390 x 300mm (15ins x 12ins) and baking trays no larger than 330 x 255mm (13ins x 10ins), these should be positioned centrally on the oven shelf.

- Do not fit shelves upside down.
- Never use more than 3 shelves in the oven as air circulation will be restricted.
- Food or cooking utensils should not be placed on the floor of the oven.

To avoid unnecessary cleaning, rod shelves which are not in use should be removed from the oven.

FAN OVEN

TEMPERATURE AND TIME

When all three shelves are used to cook large quantities of food for home freezing or parties, it may be necessary to increase the cooking times given in the charts by a few minutes to allow for the loss of heat due to the extra time taken to load the oven, and the larger mass of food. Baking trays should allow an equal gap on all sides of the oven.

NB. Recipes in cookery books give times and temperatures for cooking in ordinary ovens. The fan oven makes it possible in most cases to:

- Reduce the recommended temperatures 25°C (45°F).
- Reduce the recommended time by approximately 10 minutes per hour.
- Make pre-heating the oven unnecessary for certain foods.

TO PREPARE MEAT AND POULTRY FOR ROASTING IN YOUR FAN OVEN

- Wipe the meat or poultry, dry well and weigh it. Meat which has been stored in a refrigerator should be allowed to come to room temperature before cooking and frozen meat or poultry must be completely defrosted before placing in the oven.
- The weight of any stuffing used should be added before calculating the cooking time.
- Place meat / poultry in the main oven meat pan supplied with your cooker. Small joints weighing less than 1.75kg (3 1/2lb) should be roasted in a smaller meat pan / tin - or they may be 'pot roasted' - a small joint in a large meat pan causes unnecessary oven splashing and evaporation of meat juices.
- Additional fat should not be added, except for veal, very lean meat or poultry which can be 'larded' with bacon fat or brushed very sparingly with cooking oil or melted fat.
- Beef, lamb, mutton and poultry may be dusted lightly with seasoned flour to give a crisp outer surface. The skin of duck and goose should be pricked to release excess fat during cooking and the rind of pork should be scored, brushed lightly with oil and rubbed with salt to give crisp crackling.
- Meat and poultry wrapped in, or covered with a tent of aluminium foil will be juicy and tender. Roasting bags offer the same advantage. Always follow the manufacturer's packing instructions and remember to reduce the temperatures given for conventional ovens by approximately 25°C and the time by approximately 10 minutes per hour.
- Potatoes for roasting only require to be brushed with cooking oil or melted fat.
- It is not necessary to baste when roasting in an electric oven and stock or liquid should not be added to the meat pan since this only causes unnecessary soiling, steam and condensation.

FROZEN MEAT AND POULTRY

Joints of meat and whole birds should be defrosted slowly, preferably in a domestic refrigerator (allowing 5-6 hours per 450g, 1lb), or at room temperature (allowing 2-3 hours per 450g, 1lb). Frozen meat or poultry must be completely defrosted before placing in the oven. It is essential to wash thoroughly and cook meat and poultry immediately after defrosting.

CONVENTIONAL OVEN

OVEN CONTROL

Heating of the oven is achieved by turning the control clockwise to the required oven temperature scale on the control panel, as recommended in the temperature charts. The pilot light will immediately come on and off during cooking as the thermostat maintains the correct temperature.

The charts on pages 20 and 21 are a guide only, giving approximate cooking temperatures and times. To suit personal taste and requirements, it may be necessary to increase and decrease temperatures by 10°C.

The oven is fitted with 'heat clean' liners and two rod shelves. The heating of the oven is achieved by turning the control knob clockwise to the required temperature as recommended in the temperature charts. The pilot light will immediately come on and will automatically go off and on during cooking as the oven thermostat maintains the correct temperature.

It should be noted that at the end of a cooking period there may be a momentary puff of steam when the oven door is opened. This will disperse in a few seconds and is a perfectly normal characteristic of an oven with a good seal.

The correct positioning of food is indicated on the temperature charts.

TO PREPARE MEAT FOR ROASTING IN YOUR CONVENTIONAL OVEN

Wipe the joint, dry well with a clean cloth, kitchen tissue etc. and weigh it. Meat which has been stored in a refrigerator should be allowed to come to room temperature for approximately 30 minutes before cooking and frozen meat or poultry must be completely defrosted beforehand.

Beef, lamb, mutton and poultry may be lightly floured, but pork should be scored, brushed lightly with oil and rubbed with salt to give crisp crackling. Place joint in the main oven meat pan supplied with your cooker. (Small joints weighing less than 1.75kg (31/2lb) should be roasted in a smaller meat pan / tin - or they may be 'pot roasted' - a small joint in a large meat pan causes unnecessary oven splashing and evaporation of meat juices). Additional fat should not be added, except for veal, very lean meat or poultry which can be 'larded' with bacon fat or brushed very sparingly with cooking oil or melted fat. It is not necessary to baste, when roasting in an electric oven and liquid / stock should not be added to the pan.

For optimum cooking performance, there must be clearance between meat pan and oven sides.

The meat pan must be placed lengthways in the oven to allow for air circulation.

TIMES AND TEMPERATURES FOR ROASTING

The secret of succulent, tender meat, is not to roast it too quickly at too high a temperature.

Best results are obtained when roasting is carried out at a low temperature. When a lower temperature is used, the joint loses less weight, is more tender (too high a temperature causes meat to be tough and dry) and the splashing of fat onto oven interior is reduced to a minimum.

When a complete meal is being cooked in the oven, cooking time may need to be increased and temperature may need to be raised for approximately the last 30 minutes of the cooking period (for instance when cooking Yorkshire pudding to serve with roast beef). The suggested times and temperatures given below should be used as a guide, but may vary according to:-

1. Whether you prefer meat rare, medium or well done.
2. The size and shape of your joint.
 - (a) A short thick joint requires a longer cooking period than a long thin joint.
 - (b) A small joint under 1.5kg (3lbs) takes longer per 450g (1lb) cook in the time given for 'minutes' per 450g (1lb) without the 'minutes' over added.
 - (c) Boned/rolled and stuffed joints take longer to cook through than those with a bone. The weight of stuffing should be added to the oven ready weight of the meat / poultry to calculate roasting times.

NOTE: Remember to switch off the oven control after cooking is finished. If the door of the oven is left open for long periods of time with the control switch ON, then the grill element will become hot. The correct positioning of food is indicated in the temperature charts.

OVEN COOKING CHART - BAKING

It is not necessary to pre-heat the fan oven before roasting. Note: Where times are stated, they are approximate only.

Conventional Oven				
Meat	Pre-heat	Temperature °C	Time (approx.)	Position in Oven from bottom
Beef	Yes	190/200	25-30 mins per 450g (1lb) +25 mins over.	In meat pan on runner 2
Lamb	Yes	190/200	25-30 mins per 450g (1lb) +25 mins over.	
Pork	Yes	190/200	30-35 mins per 450g (1lb) +30 mins over.	
Veal	Yes	190/200	25-35 mins per 450g (1lb) +30 mins over	
Poultry/Game up to 4kg (8lb)	Yes	180/190	20-25 mins per 450g (1lb) +30 mins over	
Turkey up to 5.5 kg (12lb)	Yes	190	22 mins per 450g (1lb) eg. 5.5kg (11lb) = 242mins	Runner 2
Turkey over 5.5 kg (12lb)	Yes	180	18 mins per 450g (1lb) eg. 10kg (22lb) = 352mins	
Casserole Cooking	Yes	140/160	2-2½ hrs	Runner 3
If using aluminium foil, never: 1.Allow foil to touch sides of oven. 2.Cover oven interior with foil. 3.Cover shelves with foil.				

Fan Oven				
Meat	Pre-heat	Temperature °C	Time (approx.)	Position in Oven from bottom
Beef	No	160/180	20-25 mins per 450g (1lb) +20 mins over.	In meat pan on runner 2
Lamb	No	160/180	25 mins per 450g (1lb) +25 mins over.	
Pork	No	160/180	25 mins per 450g (1lb) +25 mins over.	
Veal	No	160/170	25-30 mins per 450g (1lb) + 25 mins over	
Chicken/Turkey up to 4kg (8lb)	No	160/180	18-20 mins per 450g (1lb) + 20 mins over	
Turkey up to 5.5 kg (12lb)	No	150 - 160	13-15 mins per 450g (1lb) eg. 5.5kg (11lb) = 143-165 mins	Runner 2
Turkey over 5.5 kg (12lb)	No	150	12 mins per 450g (1lb) eg. 10kg (22lb) = 264 mins	
Casserole Cooking	No	140 - 150	1½ - 2 hrs	Runner 3
If using aluminium foil, never: 1.Allow foil to touch sides of oven. 2.Cover oven interior with foil. 3.Cover shelves with foil.				

The most accurate method of testing the readiness of joints of meat or whole poultry is to insert a meat thermometer into the thickest part of a joint, or the thickest part of poultry thighs, during the cooking period. The meat thermometer will indicate when the required internal temp has been reached.

Beef - Rare: 60°C **Lamb:** 80°C **Poultry:** 90°C
 Medium: 70°C **Pork:** 90°C
 Well Done: 75°C **Veal:** 75°C

OVEN COOKING CHART - BAKING

Fan Oven Cooking			
Food	Pre-heat	Temperature and Time	Position in Oven
Scones	Yes	210/220°C approx. 8 - 10 mins.	Runner 3
Small Cakes	Yes	160/170°C approx. 15 - 20 mins.	Runner 3
Victoria Sandwich	No	160/170°C approx. 20 - 25 mins.	Runner3
Sponge Sandwich (fatless)	Yes	160/170°C approx. 15 - 20 mins.	Runner 3
Swiss Roll	Yes	170/180°C approx. 12 - 15 mins.	Runner 3
Rich Fruit cakes	No	120/130°C dependent on use	Runner 2
Semi-Rich Cakes	No	140/150°C approx. 1¼ - 2¼ hrs.	Runner 3
Shortcrust Pastry	No	180/190°C approx. 45 - 50 mins.	Runner 2
Puff Pastry	No	190/200°C dependent on use	Runner 2 & 5
Yorkshire Pudding	Yes	170/180°C approx. 40 - 45 mins.	Runner 3
Individual Yorkshire Pudding	Yes	180/190°C approx. 20 - 25 mins.	Runner 3
Milk Pudding	No	130/140°C approx. 1¼ - 2¼ hrs.	Runner 2
Baked Custard	No	140/150°C approx. 40 - 50 mins.	Runner 2
Bread	Yes	200/210°C approx. 40 - 45 mins.	Runner 2
Meringues	No	70/80°C approx. 3 - 4 hrs.	Runner 1

Conventional Oven Cooking			
Food	Pre-heat	Temperature and Time	Position in Oven
Scones	Yes	220/230°C approx. 10 - 15 mins.	Runner 3
Small Cakes	Yes	180/190°C approx. 20 - 25 mins.	Runner 3
Victoria Sandwich	Yes	170/180°C 6½" - 7" tins approx. 20 - 25 mins.	Runner3
Sponge Sandwich (fatless)	Yes	190/200°C 7" tins 15 - 20 mins.	Runner 3
Swiss Roll	Yes	190/200°C approx. 10 - 15 mins.	Runner 3
Rich Fruit cakes	Yes	130/140°C dependent on use	Runner 2
Semi-Rich Cakes	Yes	160/170°C 7" - 8" tins 1¼ - 1½ hours	Runner 3
Shortcrust Pastry	Yes	190/200°C depending on use	Runner 2
Puff Pastry	Yes	220°C approx. dependent on use	Runner 2 & 5
Yorkshire Pudding	Yes	200/210°C 30 - 45 mins.	Runner 3
Individual Yorkshire Pudding	Yes	210/220°C approx. 20 - 25 mins.	Runner 3
Milk Pudding	Yes	150/160°C approx. 2 - 2½ hours	Runner 2
Baked Custard	Yes	150/160°C approx. 45 - 55 mins.	Runner 2
Bread	Yes	220/230°C 50 - 60 mins. reducing to 210/220°C 230°C 45-50 mins after first 10 minutes	Runner 2
Meringues	Yes	100/110°C Large 3½ - 4½ hours Small 2½ - 3 hours	Runner 1

Note: If soft margarine is used for cake making, temperatures recommended by the manufacturers should be followed. Temperatures recommended in this chart refer to cakes made with block margarines or butter only.

THE 'SLOW COOK' SETTING

With the fanned oven thermostat set to **90°** the oven can be used for slow cooking - The 'Slow Cook' setting.

PREPARING FOOD FOR SLOW COOKING

1. All dishes cooked by the 'Slow Cook' setting should be cooked for a minimum 6 hours. They will 'hold' at this setting for a further hour but marked deterioration in appearance will be noticed in some cases.
2. Joints of meat and poultry should be cooked at 170° for 30 minutes before turning to the 'Slow Cook' setting and never be cooked lower than the middle shelf position.
3. Joints of meat over 6 lbs (2.7kg) and poultry over 4 lbs 8oz (2 kg) should not be cooked using the 'Slow Cook' setting.
4. Always stand covered joints on a rack over the meat tin to allow good air circulation.
5. A meat thermometer should be used when cooking pork joints and poultry. The internal temperature of the food should reach at least 88°C.
6. This method is unsuitable for stuffed meat and stuffed poultry.
7. Always bring soups, casseroles and liquids to the boil before putting in the oven.
8. Cover casseroles with foil and then the lid to prevent loss of moisture.
9. Always thaw frozen food completely before cooking.
10. Root vegetables will cook better if cut into small pieces.
11. Adjust seasonings and thickenings at the end of the cooking time.
12. Use the zones of heat in the oven, e.g. meringues and milk puddings can be cooked lower in the oven whilst other dishes requiring greater heat can be cooked above them.
13. Egg and fish dishes need only 1-5 hours cooking and should be included in day cooking sessions, when they can be observed from time to time.
14. Dried red kidney beans must be boiled for a minimum of ten minutes after soaking, before inclusion in any dish.

WARMING COMPARTMENT

The warming compartment is situated at the bottom right hand side of the cooker. It can be used for keeping plates or food warm. It is not designed as a 'Slow Cook' oven.

CARE AND CLEANING

! Never use steam cleaners or pressure cleaners on the appliance.

! Clean the glass part of the oven door using a sponge and a non-abrasive cleaning product, then dry thoroughly with a soft cloth. Do not use rough abrasive material or sharp metal scrapers as these could scratch the surface and cause the glass to crack.

! The accessories can be washed like everyday crockery (even in your dishwasher).

! Switch off the electricity supply and allow to cool before cleaning the cooker.

! Clean the cooker regularly and wipe up spills soon after they occur to prevent them from becoming burnt on. Never use biological washing powder, caustic cleaners, harsh abrasives, scouring pads, steam cleaners, aerosol cleaners or oven chemical cleaners of any kind.

! Before moving your cooker ensure that it is cool and note that it is heavy so you may require assistance. The cooker is fitted with rear wheels and will slide in and out of position easily.

Movement of your cooker is most easily achieved as follows:

Open the grill/oven door sufficiently to allow a comfortable grip on the underside front edge of the oven roof, avoiding contact with any grill or oven furniture and then lift and slide at the same time.

When repositioning the cooker, ensure that it is level. Take care to ensure that any floor covering is not damaged.

'HEAT CLEAN' LINERS

The oven linings are coated with a special enamel which has a continuous cleaning action. The higher the oven temperature the more effective the action. In most cases this cleaning operation will proceed during normal cooking.

However, if high temperatures are not used regularly it may be necessary to run the oven empty at maximum setting for one hour. If desired, they can be wiped over with a soapy cloth followed by a wipe with a clean, damp cloth.

CLEANING THE GRIDDLE PLATE

After cooking, leave the griddle plate on the hob and allow to cool before cleaning. It can then be taken to the sink and washed using warm soapy water, gently wipe the cooking surface with a dishcloth. DO NOT use abrasive cleaning materials.

REPLACEMENT OF OVEN LIGHT BULB

CAUTION: DISCONNECT THE APPLIANCE FROM THE ELECTRICITY SUPPLY BEFORE REPLACING THE LAMP TO AVOID THE POSSIBILITY OF AN ELECTRIC SHOCK.

Light bulbs are not covered by the manufacturer's guarantee.

A new 15W, 300°C rated SES bulb can be obtained from your cooker supplier or any major electrical retailer.

1. Remove the shelves from the oven.
2. Unscrew the lens using a thick cloth to protect your fingers in the unlikely event of a lens fracture.
3. Unscrew bulb.
4. Fit new bulb and refit lens.

CARE AND CLEANING

COOKER FINISH	CLEANING METHOD
<p>Vitreous Enamel Hotplate (Traditional), pan supports, burner caps, roasting dish, grill pan, oven base, rear and roof, door inner panels, grill and warming compartments.</p>	<p>Cloth wrung out in warm soapy water. Stubborn stains can be removed with a cream paste, liquid cleaner or by rubbing with fine steel wool soap pads e.g. Brillo, Ajax. Check that the cleaning agent is approved by the Vitreous Enamel Association.</p>
<p>Aluminium Burner bodies, door handles.</p>	<p>Similar to paint cleaning above. Use a nylon brush to remove any cleaning materials, water or dirt from the hotplate burner ports. Care should be taken when refitting the bodies over the electrodes.</p>
<p>Glass</p>	<p>As for enamel cleaning. Polish with a clean dry cloth or kitchen roll.</p>
<p>Chromium Plating Oven shelves, grill pan grid, grill pan handle support.</p>	<p>Wipe with a cloth wrung out in warm soapy water. A fine steel wool soap pad e.g. Brillo, Ajax, or a chrome or stainless steel cleaner may be used.</p>
<p>Plastic Grill pan handle, control knobs, door handle supports.</p>	<p>Wipe with a cloth wrung out in warm soapy water.</p>
<p>Stainless Steel (Professional) Door trims, control panel, hotplate</p>	<p>Wipe with a cloth wrung out in warm soapy water. Polish with a clean dry cloth or kitchen towel. For stubborn stains, use a proprietary stainless steel cleaner and follow the instructions on the container.</p>
<p>Paint Control panel and doors (Traditional), side panels</p>	<p>Wipe with a cloth wrung out in warm soapy water only. DO NOT USE ABRASIVES.</p>

SOMETHING WRONG WITH YOUR COOKER

Before contacting your nearest Service Centre/Installer, check the problem guide below; there may be nothing wrong with your cooker.

PROBLEM	CHECK
Slight odour or small amount of smoke when grill/oven used for first time.	This is normal and should cease after a short period.
Oven cooks too fast or too slow.	Check that the oven setting and shelf positions are as recommended in the Cooking Charts. However, it may be necessary to increase or decrease the recommended setting slightly to suit your taste.
Ignition does not work:	<p><u>If all burners fail to ignite:</u> Check that sparks appear at the burners; a clicking noise should be heard. If not;</p> <p>(i) Check that the electricity supply is turned on. (ii) Check other appliances to see if you have had a power cut.</p> <p><u>If only one burner fails to ignite:</u> (i) Check the burner cap is seated correctly. (ii) Check the slots in the burner bodies are not blocked with any soap residue or cooking soil (see care and cleaning). (iii) Check, if the burners have recently been cleaned using a wire wool pad eg. "Brillo Pad", ensure that no stray strands are caught on the ignitor or burner body.</p> <p>NOTE. Satisfactory ignition will only be achieved if all the hotplate burners are fitted. In the event of an electricity failure, all burners can be lit with a match.</p>
Cannot set an "Auto Cook" programme or cannot get the timer to turn the oven on or off at the required times.	Read the Timer instructions in this book carefully remembering that the Cook period is the length of time that the timer will switch the oven(s) on as part of an Auto Cooking Programme.
Timer Display shows "0:00" with "AUTO" Flashing.	The electricity supply to the cooker may have been interrupted, but has now come back on again. Set the correct time of day by following the instructions given in the timer section of this book.
Fanned oven does not work, but the grill, top oven and hotplate burners work.	The Timer may be set for an Auto Cooking programme. Check the Timer to see if "AUTO" is illuminated. If it is, follow the instructions given in the Timer section of this book to cancel the Auto Cooking programme.
Oven lamp does not work.	The oven lamp is not covered by the guarantee. The part is easily changed (see the section on oven lamp replacement). A new lamp may be obtained from our Parts department, (see back page).

If there is still a problem contact your local Service office (see back page).

Disposal of your product

To minimise the risk of injury to children please dispose of your product carefully and safely. Remove all doors and lids. Remove the mains cable (where fitted) by cutting off flush with the appliance and always ensure that no plug is left in a condition where it could be connected to the electricity supply.

To help the environment, Local Authority instructions should be followed for the disposal of your product.

Disposal of old electrical appliances



The European Directive 2002/96/EC on Waste Electrical and Electronic Equipment (WEEE), requires that old household electrical appliances must not be disposed of in the normal unsorted municipal waste stream. Old appliances must be collected separately in order to optimise the recovery and recycling of the materials they contain and reduce the impact on human health and the environment.

The crossed out "wheeled bin" symbol on the product reminds you of your obligation, that when you dispose of the appliance it must be separately collected.

Consumers should contact their local authority or retailer for information concerning the correct disposal of their old appliance.

INSTALLATION INSTRUCTIONS

Prior to installation, ensure that the local distribution conditions (nature of the gas and gas pressure) and the adjustment conditions are compatible. The adjustment conditions for this appliance are stated on the data badge which is fitted on the back panel.

This appliance is not designed to be connected to a combustion products evacuation device. It must be installed and connected in accordance with current installation regulations. Particular attention should be given to the relevant requirements regarding ventilation.

MODEL NUMBERS 10450G, 10455G, 10456G

Category II2H3+ (GB. IE)

This model is set to burn NATURAL GAS (G20) at 20 mbar but can be converted for use on BUTANE (G30) at 28-30mbar or PROPANE (G31) at 37mbar with the use of a service kit supplied with the appliance or available from our Service and Genuine Parts and Accessories department (see back cover).

GAS SAFETY (INSTALLATION & USE) REGULATIONS

It is the law that all gas appliances are installed by competent persons in accordance with the current edition of the above regulations. It is in your interest and that of safety to ensure compliance with the law.

In the UK, CORGI registered installers work to safe standards of practice.

The cooker must also be installed in accordance with BS 6172.

Failure to install the cooker correctly could invalidate the warranty liability claims and could lead to prosecution.

LOCATION

The cooker may be located in a kitchen, kitchen/diner or a bed-sitting room, but not in a room containing a bath or shower. The cooker must not be installed in a bed-sitting room of less than 20m³.

When adjusted for use on BUTANE (G30) or PROPANE (G31) the cooker must not be installed in a room or internal space below ground level, eg. in a basement.

PROVISION FOR VENTILATION

The room containing the cooker should have an air supply in accordance with BS 5440: Part 2.

The room must have an opening window or equivalent; some rooms may also require a permanent vent. If the room has a volume between 5 and 10m³, it will require an air vent of 50cm² effective area unless it has a door which opens directly to outside. If the room has a volume of less than 5m³, it will require an air vent of 100cm² effective area. If there are other fuel burning appliances in the same room, BS 5440: Part 2 should be consulted to determine air vent requirements.

INSTALLATION INSTRUCTIONS

TECHNICAL DATA

DIMENSIONS

Height	900 - 915 mm
Widht	1000 mm
Depth	600 mm (excluding door handles)

GENERAL

Gas connection	Rp ½ (½" BSP female)
Pressure test point	Hotplate burner injector
Gas rate adjustment	None
Aeration adjustment	None
Electrical connection	230-240V~ 50Hz.
Total electrical heat input	6.00-6.80 kW

	230-240V~	Cat I12H3+ G20 at 20 mbar		Cat I12H3+ G30 at 28 - 30 mbar G31 at 37 mbar			
		HEAT INPUT	HEAT INPUT	INJECTOR	HEAT INPUT	GAS RATE	INJECTOR
BURNER							
HOTPLATE Front Left		1.90 kW	102 Z	2.00 kW	138 g/hr	65	35
HOTPLATE Rear Left		3.00 kW	116 Y	3.00 kW	218 g/hr	86	44
HOTPLATE Wok Outer Centre Front		4.10 kW	110 x 2	4.10 kW	298 g/hr	70 x 2	57
HOTPLATE Wok Inner Centre Front		1.00 kW	74	0.90 kW	73 g/hr	44	24
HOTPLATE Auxiliary Centre Rear		1.00 kW	71 X	1.00 kW	73 g/hr	50	24
HOTPLATE Front Right		1.50 kW	88 X	1.50 kW	110 g/hr	60	35
HOTPLATE Rear Right		1.50 kW	88 X	1.50 kW	110 g/hr	60	35
TWIN GRILL	2.50 kW						
L/H OVEN	1.60 kW						
R/H OVEN	1.80 kW						
WARMING DRAWER	0.15 kW						

INSTALLATION INSTRUCTIONS

CONVERSION FOR USE ON BUTANE OR PROPANE

Each hob burner requires the injector to be replaced and each burner gas tap to have the by-pass screw adjusted according to the following procedure:

1. Lift off the burner cap and the burner body and place it to one side.
2. Remove the injector from the burner base with a suitable box spanner and discard.
3. Replace the injector with the appropriate replacement (see Table on page 28).
4. Repeat for each burner.
5. Replace the burner bodies and caps, taking care that they are positioned correctly.
6. Remove the tap knob from the left hand hotplate tap. Insert a narrow flat screwdriver centre of the tap spindle and turn fully clockwise. Replace the tap knob. Repeat this procedure with the other six hotplate taps.
7. Position and fix the self-adhesive LPG conversion label over the gas details on the rating plate label.

INSTALLATION INSTRUCTIONS

SPACE FOR FIXING

The cooker can be close fitted below hotplate level. This requires a minimum distance of 600mm between cupboard units of hotplate height.

When installing next to a tall cupboard, partition or wall, for a minimum distance of 400mm above hotplate level, allow a side clearance of at least 65mm.

The diagram below illustrates the minimum clearance between the cooker and adjacent walls, cupboards etc.

The wall behind the cooker, 50mm below and 450mm above, and the width of the cooker, must be a non-combustible material such as ceramic wall tiles.

If the cooker is to be fitted close to a corner on the left hand side, ensure that there is a clearance of at least 50mm to allow the main oven door to open fully for when removing oven shelves.

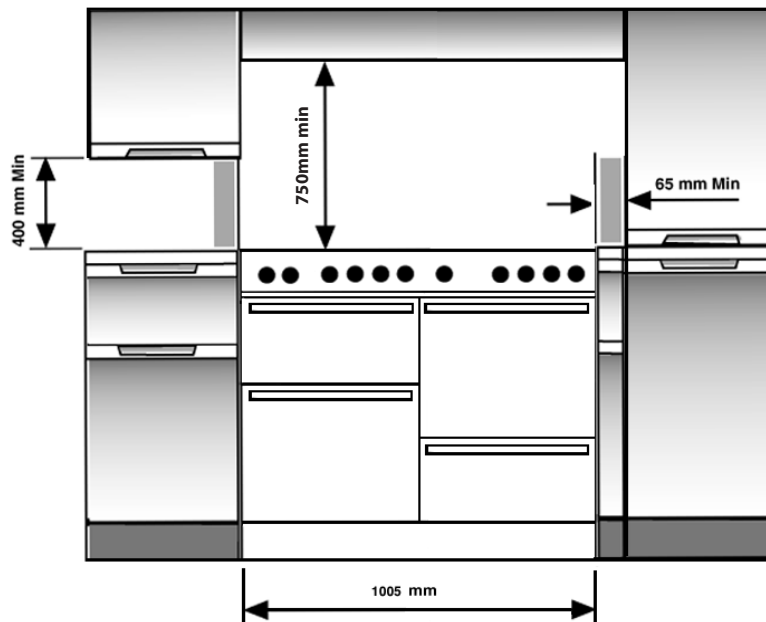

COOKER HOODS

If a cooker hood is to be installed, refer to the cooker hood manufacturers' instructions regarding fixing height.

INSTALLATION INSTRUCTIONS

UNPACKING THE COOKER

Unpack the components from inside the grill and oven. Check that the following parts are present:

Meat pan	Pan supports (3)
Grill pan, grid and handle	LPG conversion kit
Loose burner parts (14)	Oven shelves (4)
Aluminium burner bodies (6)	Griddle
Wok Stand	Literature pack

After unpacking your cooker, make sure that you remove all the packing from the oven and grill, and any stickers from the oven door and the hob.

LEVELLING

Your cooker is heavy, so it would be advisable for two people to move it. The cooker is fitted with rear wheels and will slide into position easily. Movement of your cooker is most easily achieved as follows. Open the grill/oven door sufficiently to allow a comfortable grip on the underside front edge of the oven roof, avoiding any grill or oven interior furniture, and then lift and slide back at the same time.

Your cooker must stand on a flat surface so that the hob is perfectly level, and the cooker is stable and cannot be rocked, this is easily achieved by adjusting the three feet which are under the front of the cooker and the 3 castors under the rear of the cooker, if necessary.

STABILITY BRACKET

The cooker must be fitted with a stability device firmly secured to the fabric of the building.

The M6 bolt at the top of the rear of the cooker can be used to engage a stability chain. Keep the chain clear of controls and pipes on the rear of the cooker.

The chain must be fitted to the wall behind the cooker.

NOTE: If the cooker is to be placed on a base, precautions must be taken to prevent it from slipping off the base.

INSTALLATION INSTRUCTIONS

The cooker is designed to match the depth of standard 600mm worktops.

An adaptor backplate should, therefore, be fitted within the shaded area shown to allow the cooker to be pushed fully to the wall. If a forward facing backplate is used, it must be chased into the wall.

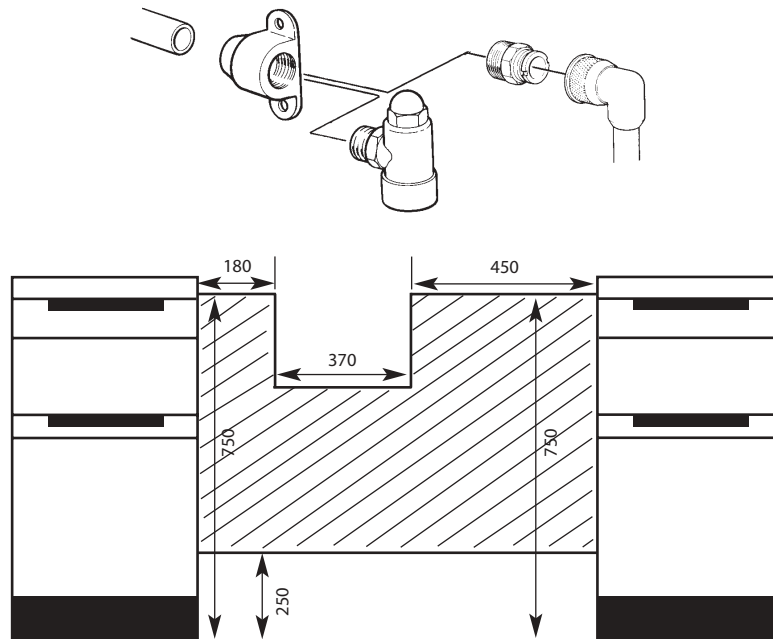

Connection to the cooker should be made with an approved appliance flexible connection to BS 669. A length of 0.9 to 1.25m is recommended. The length of hose chosen should be such that when the cooker is in situ, the hose does not touch the floor.

The temperature rise of areas at the rear of the cooker that are likely to come in contact with the flexible hose do not exceed 70°C.

LPG cookers should be connected with a hose suitable for LPG and capable of withstanding 50mbar pressure.

INSTALLATION INSTRUCTIONS

WARNING - THIS APPLIANCE MUST BE EARTHED

Your cooker should have been checked to ensure that the voltage corresponds with your supply voltage, which is stated on the data badge fitted on the rear panel.

The cooker must be connected by a contractor/engineer who is registered with the National Inspection Council for Electrical Installation Contracting (NICEIC), to a suitable double - pole control unit with a minimum rating of 30A and a minimum contact clearance of 3mm, which should be fitted adjacent to (but not above) the cooker, in accordance with IEE regulations.

The power supply cable should conform to BS6004 with a conductor size of 4mm².

The power supply cable must be type H05RR-F 3x4mm².

The control unit should be easily accessible in the event of an emergency.

This appliance conforms to EN55014 regarding suppression of radio and television interference.

Access to the mains terminals is gained by removing the rear access cover.

The mains cable must pass through the cable clamp adjacent to the terminal block.
Sufficient cable should be used to allow the cooker to be pulled out for servicing.

INSTALLATION & OPERATIONAL CHECKS

After installation, check for gas soundness.

Fit the hotplate burner bodies, burner port rings, enamelled discs and pan supports referring to the instructions for use where necessary.

1. Check that the hotplate burners ignite correctly and burn with a steady flame.
Check for a steady flame on the low setting.
2. Check that with the left hand oven set at 230°C, the oven fan operates and the oven heats up.
3. Check that with the right hand oven set at 230°C, the oven heats up.
4. Check that the twin grill heats up.
5. Check that the warming drawer heats up.
6. Check operation of clock.

Instruct the user on the operation of the cooker.





Guarantee

12 months Parts and Labour Guarantee

Your appliance has the benefit of our manufacturer's guarantee, which covers the cost of breakdown repairs for twelve months from the date of purchase.

This gives you the reassurance that if, within that time, your appliance is proven to be defective because of either workmanship or materials, we will, at our discretion, either repair or replace the appliance at no cost to you.

The guarantee is subject to the following conditions:

- The appliance has been installed and operated correctly and in accordance with our operating and maintenance instructions.
- The appliance is only used on the electricity or gas supply printed on the rating plate.
- The appliance has been used for normal domestic purposes only.
- The appliance has not been altered, serviced, maintained, dismantled or otherwise interfered with by any person not authorised by us.
- Any repair work must be undertaken by us or our appointed agent.
- Any parts removed during repair work or any appliance that is replaced become our property.
- The appliance is used in the United Kingdom or Republic of Ireland.

The guarantee does not cover:

- Damage resulting from transportation, improper use, neglect or interference or as a result of improper installation.
- Replacement of any consumable item or accessory. These include but are not limited to: plugs, cables, batteries, light bulbs, fluorescent tubes and starters, covers and filters.
- Replacement of any removable parts made of glass or plastic.

THE GUARANTEE WILL NOT APPLY IF THE APPLIANCE HAS BEEN USED IN COMMERCIAL OR NON-DOMESTIC PREMISES.

5 Year Parts Guarantee

Cannon also offers you a FREE 5 year parts guarantee. This additional guarantee is conditional on you registering your appliance with us and the parts being fitted by one of our authorised engineers. There will be a charge for our engineer's time. To activate the extra parts warranty on your appliance, simply call our registration line on **08448 24 24 24 (ROI 01 230 0800)**

Extended Guarantees

We offer a selection of protection plans that enable you to fully cover yourself against the expense of repair bills for the life of your policy. To find the ideal plan for you please call our advice line on **08448 226 226 (ROI 01 230 0233)**.

Free Helpdesk Service

We have a dedicated team who can provide free advice and assistance with your appliance if you experience any technical difficulties within the first 90 days of ownership. Simply call our Cannon Service Hotline on **08448 224 224 (ROI 0818 313 413)** for telephone assistance, or, where necessary, to arrange for an engineer to call.



After Sales Service

No one is better placed to care for your Cannon appliance during the course of its working life than us - the manufacturer.

Essential Contact Information

Cannon Service

We are the largest service team in the country offering you access to 400 skilled telephone advisors and 1000 fully qualified engineers on call to ensure you receive fast, reliable, local service.

UK: 08448 224 224

Republic of Ireland: 0818 313 413

www.cannonservice.co.uk

Please note: Our advisors will require the following information:

Model number

Serial number

Parts & Accessories

We supply a full range of genuine replacement parts as well as accessory products that protect and hygienically clean your appliance to keep it looking good and functioning efficiently throughout its life.

UK: 08448 225 225

Republic of Ireland: 0818 313 413

www.cannonservice.co.uk

Appliance Registration

We want to give you additional benefits of Cannon ownership. To activate your FREE 5 year parts guarantee you must register your appliance with us.

UK: 08448 24 24 24

Republic of Ireland: 01 230 0800

www.cannonservice.co.uk

Indesit Company UK Limited, Morley Way, Peterborough, PE2 9JB
Indesit Company, Unit 49 Airways Industrial Estate, Dublin 17

Recycling and Disposal Information

As part of Cannon's continued commitment to helping the environment, Cannon reserves the right to use quality, recycled components to keep down customer costs and minimise material wastage.

Please dispose of packaging and old appliances carefully. To minimise the risk of injury to children, remove the door, plug, and cut the mains cable off flush with the appliance. Dispose of these parts separately to ensure that the appliance can no longer be plugged into mains socket, and the door cannot be locked shut.

03/2009 Part no. 195044520.07