

User
Manual

Cooker

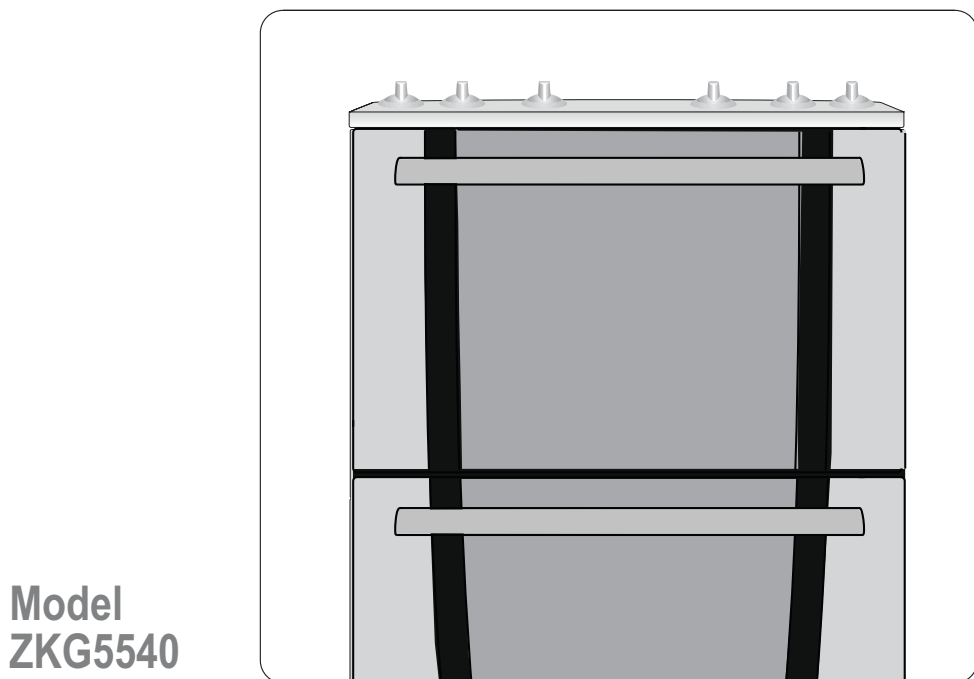

Model
ZKG5540

The following symbols are used in this user manual:



WARNING!

Important information concerning your personal safety and information on how to avoid damaging the appliance.

IMPORTANT!

General information and tips



Environmental information

Contents

Important safety instructions.....	3	Oven cooking chart.....	22
Product description.....	5	Roasting chart.....	24
Controls and their functions.....	5	Slow cook.....	25
Before first use.....	6	Food preparation – slow cooking.....	26
Grill and oven furniture.....	7	Care and cleaning.....	27
The electronic timer.....	8	Troubleshooting.....	31
The hob.....	13	Technical data.....	33
The grill.....	15	Installation instructions.....	35
Grilling chart.....	17	Environment.....	40
The top oven.....	18	Guarantee / Customer care.....	41
The main oven.....	20		

Important safety instructions

These warnings are provided in the interests of your safety. Ensure that you understand them all before installing or using the appliance. Your safety is of paramount importance. If you are unsure about any of the meanings of these warnings please contact customer care.

WARNING!

This appliance is intended for cooking purposes only. It must not be used for other purposes, for example room heating.

WARNING!

The grill door must be left open when grilling.

Installation

WARNING!

This appliance is not suitable for installation in flats or other multi occupancy dwellings as defined in clause 8.2.1 of IGE/G/5.

- The appliance must be installed according to the instructions supplied. The installation work must be undertaken by a competent person as stated in the Gas Safety (Installation & Use) Regulations current editions and the IEE Wiring Regulations.
- The appliance should be serviced by an authorised Service Engineer and only genuine approved spare parts should be used.

- It is important that the appliance is suitable for your gas supply. Your installer should check the rating plate.
- Make sure that a stability chain is fitted.
- The appliance must be installed in an adequately ventilated room.
- If the appliance is to be placed on a base, measures must be taken to prevent the appliance from slipping.
- This appliance is heavy and care must be taken when moving it.
- Do not attempt to lift or move this appliance by the handles.
- All packaging, both inside and outside the appliance must be removed before the appliance is used.
- It is dangerous to alter the specifications or modify the appliance in any way.

Child safety

- Do not allow children to play with any part of the packaging.
- Do not allow children to sit or climb on the drop down doors.
- This appliance is not intended for use by children and other persons whose physical, sensory or mental capabilities or lack of experience and knowledge prevents them from using the appliance safely without supervision or instruction by a responsible person to ensure that they can use the appliance safely.
- Children should be supervised to ensure that they do not play with the appliance.

WARNING!

Accessible parts may be hot during use. Young children should be kept away.



Product description

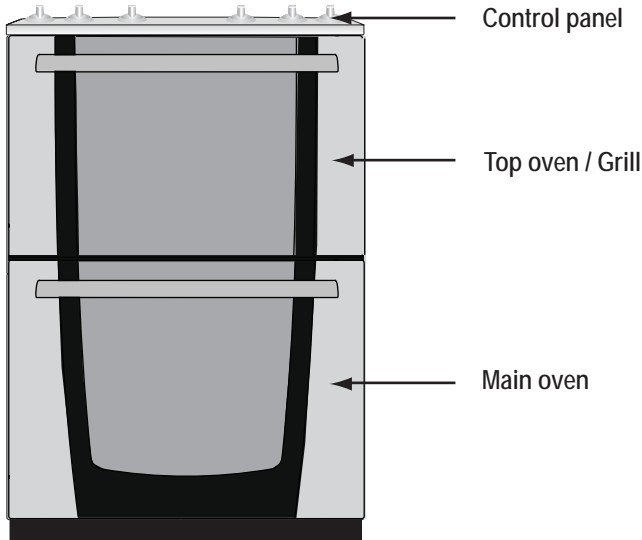

Controls and their functions

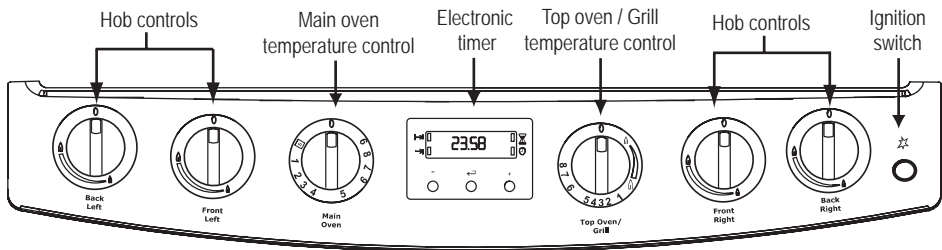

Before using the appliance

Rating plate

- This is usually situated on the front frame of the appliance and can be seen upon opening either the main or top oven door. Alternatively the rating plate may also be found on the back or top of some models (where applicable).
- The appliance must be protected by a suitably rated fuse or circuit breaker.
- The rating of the appliance is given on the rating plate.
- **Do not remove the rating plate from the appliance as this may invalidate the guarantee.**

Preparing to use your appliance

- Wipe over the base of the oven(s) with a soft cloth using hot soapy water. Wash the furniture before use.
- We suggest that you run the oven(s) and grill for 10 – 15 minutes at maximum temperature, to burn off any residue from their surfaces. Accessible parts may become hotter than in normal use. Children should be kept away. During this period an odour may be emitted, it is therefore advisable to open a window for ventilation.

Condensation and steam

- When food is heated it produces steam similar to a boiling kettle. The vents allow some of this steam to escape. However, always stand back from the appliance when opening the door(s) to allow any build up of steam or heat to release.
- If the steam comes into contact with a cool surface on the outside of the appliance, e.g. a trim, it will condense and produce water droplets. This is quite normal and is not caused by a fault on the appliance.
- To prevent discolouration, regularly wipe away condensation and foodstuff from surfaces.
- For your safety wall coverings at the rear of the appliance should be securely fixed to the wall.

Cookware

- Do not use baking trays larger than 30cm x 30cm (12" x 12") as they will restrict the circulation of heat and may affect performance.

Grill and oven furniture

- The following items of grill and oven furniture have been supplied with the appliance. If you require replacements of any of the items listed below please contact your local service force centre.

1 grill pan

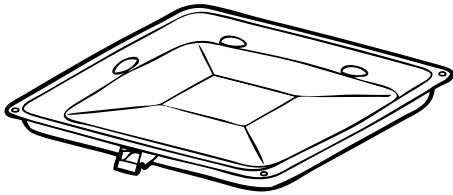

1 grill pan handle

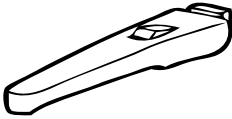

1 grill pan grid

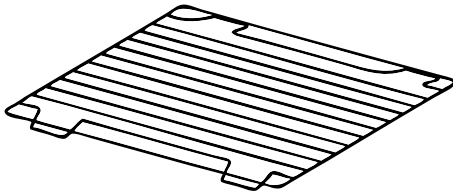

1 straight shelf (For grilling and top oven cooking)

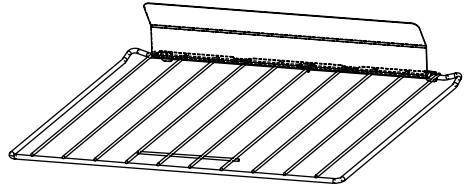

2 straight shelves (For main oven cooking)

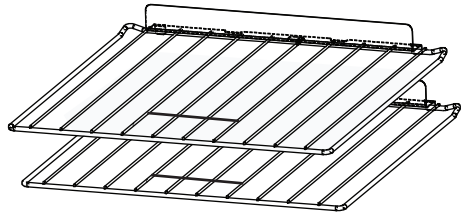

The electronic timer

This oven has a 24-hour clock.

In the event of an interruption of the electricity supply, the clock will stop and you will not be able to use the main oven.

To set the time of day

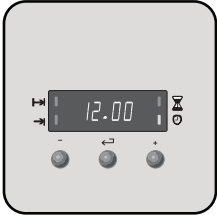

When the electricity is first switched on, the display will show 12.00 and the time indicator neon will flash.



Press the increase buttons until the correct time is showing.

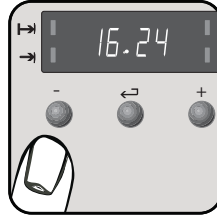

If necessary press the decrease button to help set the correct time.

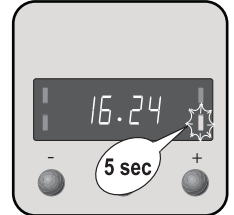

The time indicator neon will flash for 5 seconds then go out.

IMPORTANT!

The increase and decrease control buttons operate slowly at first and then more rapidly. They should be pressed separately.

To set the countdown

The 'Countdown' gives an audible reminder at the end of any period of cooking.

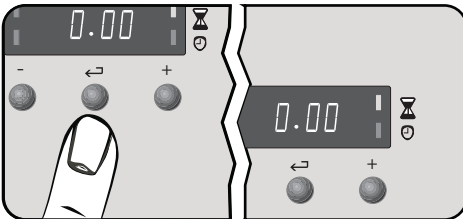

Press the selector control button until the countdown indicator neon is illuminated and the display reads 0.00

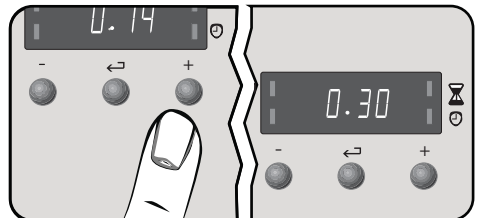

Press the increase button. Release the button once the interval to be timed is reached e.g. 30 minutes.

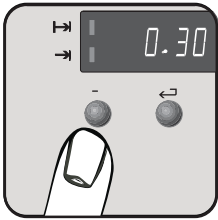

If necessary press the decrease button to achieve the correct time interval.

IMPORTANT!

This must be completed within 5 seconds of first pressing the selector control button

During the operation of the countdown the remaining time period will show in the display

At the end of the timed period a sound will be heard intermittently for up to 2 minutes.

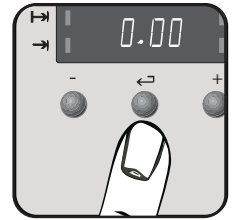

The sound can be stopped by pressing any button.

To cancel the countdown

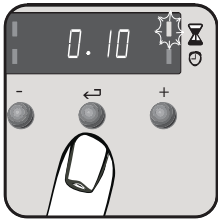

Press the selector control button until the countdown indicator neon flashes.

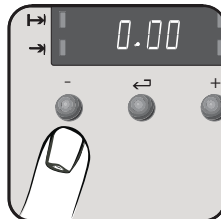

Press the decrease button until 0.00 is shown in the display.

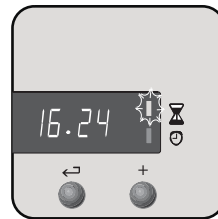

The countdown indicator neon will continue to flash for a few seconds and then return to the time of day.

Setting the oven timer control

Only the main oven can be automatically timed. When using the timer control for the very first time, it is advisable to let it operate while you are at home.

The display can be checked to show that it is operating correctly and you will feel confident to leave a meal to cook automatically in the future.

To set the timer to switch on and off automatically

Ensure the electricity supply is switched on and that the correct time of day is displayed.

Place food in oven.

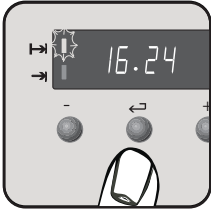

To set the length of cooking time. Press the Selector Control button until the cook time indicator neon is illuminated.

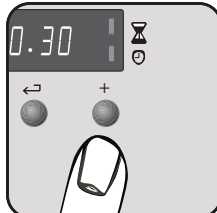

Press the increase control until the required length of cooking time is displayed.

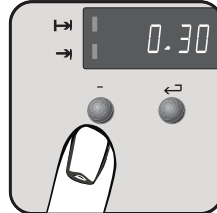

If necessary press the decrease control until the correct time interval is achieved.



Release the buttons. The cook time indicator neon will be illuminated.

IMPORTANT!

Remember, this must be completed within 5 seconds of first pressing the Selector Control button.

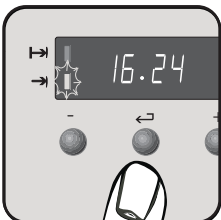

To set the 'End Time'. Press the Selector Control button until the 'End Time' indicator neon flashes.



Press the increase control until the required stop time is displayed.

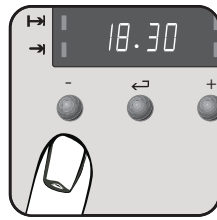

If necessary press the decrease control until the required time interval is achieved.

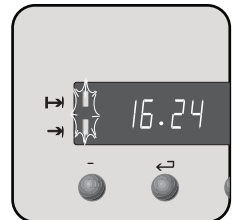

Release the buttons. The time of day will be displayed after 5 seconds. The cook time and end time indicator neons will be illuminated.

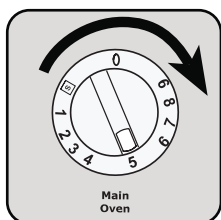
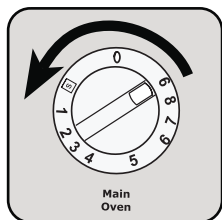

Set the main oven control to the gas mark 9 then immediately set to the required temperature.

To set the timer to switch off only

Ensure the electricity supply is switched on and that the correct time of day is displayed.

Place food in oven.

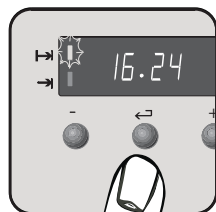

To set the length of cooking time. Press the Selector Control button until the cook time indicator neon is illuminated.

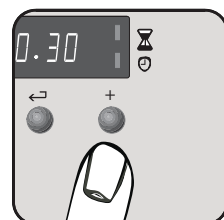

Press the increase control until the required length of cooking time is displayed.

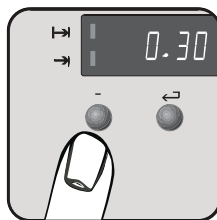

If necessary press the decrease control until the correct time interval is achieved.

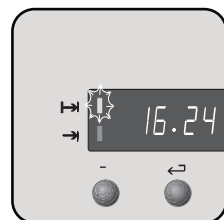

Release the buttons. The cook time indicator neon will be illuminated and the time of day will be displayed after 5 seconds.

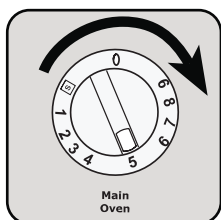
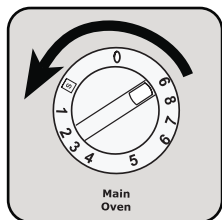

Set the main oven control to the gas mark 9 then immediately set to the required temperature.

To check the remaining cook time during the cooking period, press the selector control button once.

To cancel an automatic programme

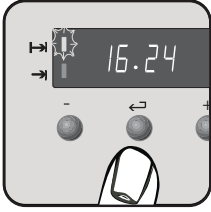

Press the selector control button until the cook time indicator neon flashes.

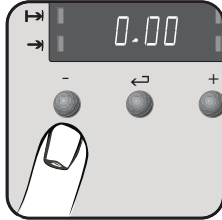

Press the decrease button until 0.00 is shown in the display.

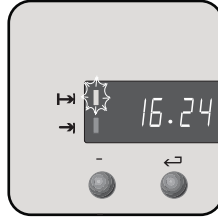

The cook time indicator neon will continue to flash for a few seconds and then return to the time of day.

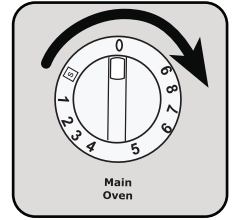

Turn off the oven controls.

To return the appliance to manual

At the end of a timed cooking period, the 'End Time' indicator neon will flash and an alarm will sound for up to 2 minutes.

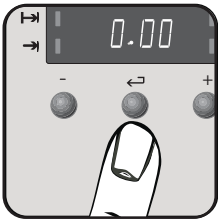

To stop the sound, press any of the three buttons.



The display will return to the time of day.

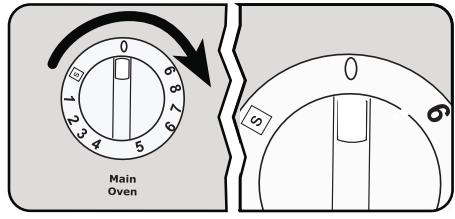

Turn the control knob to the off position. This is shown by a 0.

Things to note

In the event of an interruption of the electricity supply, the timer will reset it self to zero and all programming will be cancelled.

Your timer has an energy save mode which allows you to switch the display off. For setting details please refer to the environmental chapter of this manual.

Automatic cooking

It is advisable to leave food in the oven for as short a time as possible before automatic cooking. Always ensure commercially prepared food is well within its use by date and that home prepared food is fresh and of good quality.

When cooking is complete, do not leave food to stand in the oven, but remove and cool it quickly if the food is not to be consumed immediately. Always ensure food in the oven has been covered before cooking if it is not possible to remove food immediately after cooking.

The hob

The gas hob has different burner sizes to suit different types of cooking.

To ensure maximum burner efficiency only use pots and pans with flat bases appropriate to the burner size used.

The largest pan, which you should use on any burner, is 230mm (9") and the smallest pan should not measure less than 100mm (4").

WARNING!

Ensure the pan supports are correctly fitted before using the hob.

To light the hob burners

The hob ignition works by means of an electric spark system

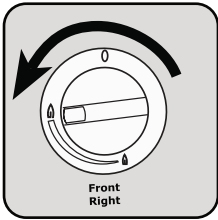

Push in and hold the control knob, turn the knob to the highest setting.

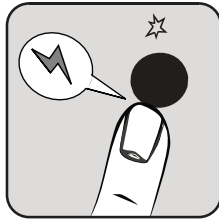

Press the ignition button immediately. Keep the control knob depressed for up to 5 seconds but no longer than 10 seconds.

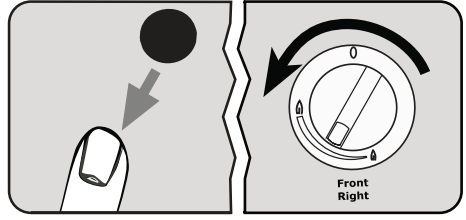

When the burner has lit release the control and ignition button, adjust the setting as required. If after 10 seconds the burner has not lit, stop operating the appliance and wait for at least 1 minute before attempting a further ignition of the burner.

WARNING!

If the ignition button is not pressed immediately a build up of gas may cause the flame to spread.

To turn off any burner

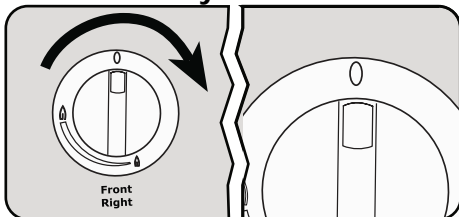

Turn the control knob to the off position. This is shown by a 0.

WARNING!

If you close the lid of the appliance while any of the hotplate burners are lit, the gas will go out. This is because it would be dangerous if the burners stayed on when the lid was closed.

WARNING!

Always use the control knob to turn off a burner. Do not use the lid as a cut-off device. This will only cut off the gas when the lid is closed. The gas will flow again when the lid is opened.

WARNING!

When lighting any burner, ensure that it is lit before you leave the appliance. When turning off a burner, ensure the flame has gone out before leaving the appliance.

Things to note

If you are having any difficulty lighting a hob burner turn all the hob controls off and make sure the burner parts have been replaced correctly.

Hints and tips

- Do not overfill pans or they will boil over.
- Do not use pans with very heavy handles, which cause the pan to tip.
- The hob surface should be allowed to cool before closing the lid.

WARNING!

Place pans on the centre of the burners. Position pans so the handles cannot be accidentally knocked or overhang the appliance. Lift pans on and off the pan supports. Do not slide them across the hob.

- Any spillage should be removed from the lid before opening.
- Do not leave accidental spillage on the hob or removable parts. The spillage should be wiped up and the parts washed and carefully dried as soon as the hob, pan supports and burner parts are cool enough to touch.
- A flat-based Wok will stand stable on the pan supports. If you use a round Wok with a collar support, the collar must be the open wirework type otherwise the performance of the burner will be affected.

WARNING!

Take care to avoid burns and scalds when reaching across the hotplate.

WARNING!

Take extra care when deep fat frying, do not cover the pan with a lid. Do not leave a pan unattended. If the pan catches fire, leave it where it is and turn off all controls. Place a damp cloth or a fitting lid over the pan to smother the flames. Never put water on the fire. Leave to cool for 30 minutes.

WARNING!

Do not use the lid as a work surface or chopping board. This could damage the glass and reduce it's strength.

IMPORTANT!

Do not allow hot pans or baking trays to touch the controls as damage may occur.

WARNING!

In the event of the burner flames being accidentally extinguished, turn off the burner control and do not attempt to re-ignite the burner for atleast 1 minute.

The grill

! CAUTION!

Accessible parts may be hot when the grill is in use. Young children should be kept away.

IMPORTANT!

When you first operate the grill you may hear some sounds as the burner heats up, this is quite normal and is not a fault on the appliance.

Using the grill

Fully open the door before lighting the grill.

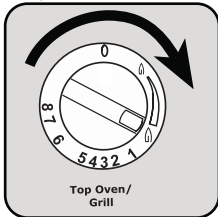

Push in and hold the control knob, turn the knob to the highest setting.

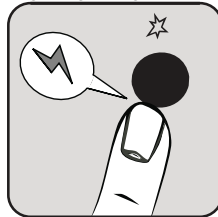

Press the ignition button immediately. Keep the control knob depressed for up to 5 seconds but no longer than 10 seconds.

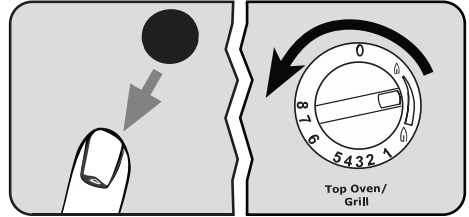

When the burner has lit release the control and ignition button, adjust the setting as required. If after 10 seconds the burner has not lit, stop operating the appliance and wait for at least 1 minute before attempting a further ignition of the burner.

! WARNING!

The grill door must be left open when grilling.

- The shelf in the grill is different from the shelves in the main oven.

Things to note

- Some smoke from fat splashes may be evident as the grill cleans itself.

! WARNING!

Never cover the grill pan or grid with foil as this can lead to grill fires.

To turn off the grill

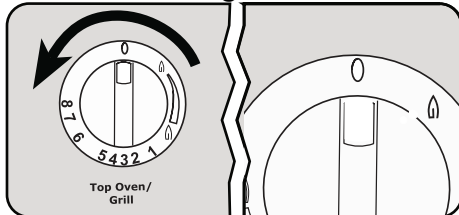

Turn the control knob to the off position. This is shown by a 0.

The grill pan and handle

The grill pan has a removable handle. Attach and remove as described below

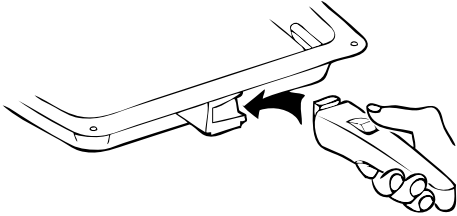

To attach. Press the button on the handle with the thumb and insert the lip into the widest part of the bracket.

Slide the handle towards the left and release the button.

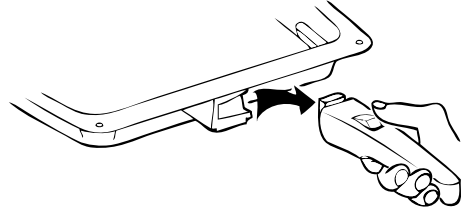

To Remove. Press the button on the handle with the thumb and slide the handle towards the right.

Release the button.

WARNING!

Ensure the handle is properly located.

Place the grill pan on the shelf so that the pan is positioned centrally beneath the grill. Ensure that the cut out on the underside of the handle bracket locates between the bars of the shelf and over the cross bar on the shelf.

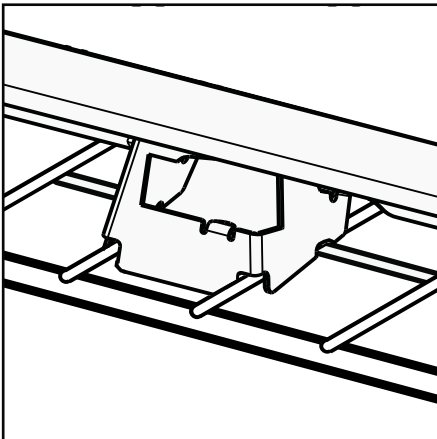

WARNING!

Protect your hands when removing the grill pan handle. Always remove the grill pan handle during grilling.

IMPORTANT!

To check the progress of the food being grilled, the grill pan should be withdrawn on the shelf to attend to food during cooking.

WARNING!

In the event of the burner flames being accidentally extinguished, turn off the burner control and do not attempt to re-ignite the burner for atleast 1 minute.

Hints and tips

- Most foods should be placed on the grid in the grill pan to allow maximum circulation of air to lift the food out of the fats and juices.
- Adjust the grid and grill pan runner position to allow for different thicknesses of food.
- Food should be thoroughly dried before grilling to minimise splashing. Brush lean meats and fish lightly with a little oil or melted butter to keep them moist during cooking.
- Accompaniments such as tomatoes and mushrooms may be placed underneath the grid when grilling meats.
- When toasting bread use the shelf in position 1 with the grid in the high position.
- Preheat the grill on a full setting for a few minutes before sealing steaks or toasting. Adjust the heat setting and the shelf as necessary during cooking.
- The food should be turned over during cooking as required.

Grilling chart

FOOD	GRILL TIME (mins in total)
Bacon Rashers	5 - 6
Beef Burgers	10 - 15
Chicken Joints	30 - 40
Lamb Chops	15 - 20
Pork Chops	20 - 30
Whole Trout/Mackerel	15 - 25
Plaice/Cod Fillets	10 - 15
Kebabs	20 - 30
Kidneys – Lamb/Pig	8 - 12
Liver – Lamb/Pig	10 - 20
Sausages	20 - 30
Steak – Rare	6 - 12
Steak – Medium	12 - 16
Steak – Well Done	14 - 20
Toasted Sandwiches	3 - 4

IMPORTANT!

The times quoted above are given as a guide and should be adjusted to suit personal taste.

Adjust the grill setting and the grill pan grid to suite different thicknesses of food.

The top oven

The top oven is the smaller of the two ovens. It is designed for cooking smaller quantities of food. Place single dishes on the centre of the shelf

The top oven is also ideal for use as warming compartment to warm dishes and keep food hot. Use the top oven when you want to warm plates. Use the lowest setting on the top oven temperature control.

Using the top oven

Fully open the door before lighting the top oven.

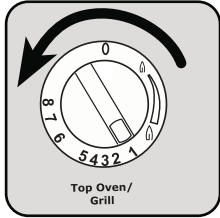

Push in and hold the control knob, turn the knob to the highest setting.



Press the ignition button immediately. Keep the control knob depressed for up to 5 seconds but no longer than 10 seconds.

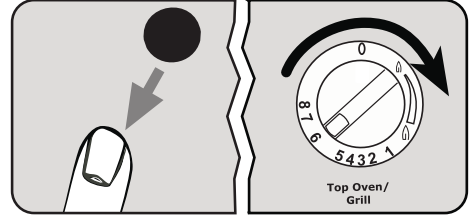

When the burner has lit release the control and ignition button, adjust the setting as required. If after 10 seconds the burner has not lit, stop operating the appliance and wait for at least 1 minute before attempting a further ignition of the burner.

IMPORTANT!

Do not close the door until the burner is showing large flames.

To turn the top oven off

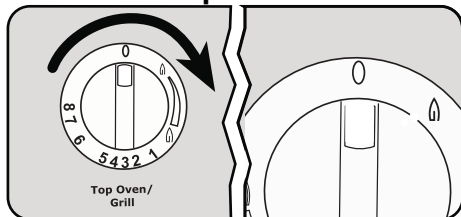

Turn the control knob to the off position. This is shown by a 0.

! WARNING!

Do not place dishes, tins and trays directly on the oven base as it becomes very hot and damage will occur.

To fit the top oven shelf

Only use the shelf with the large solid metal plate at the rear of the shelf in the top oven. The shelf should be fitted with the straight rods uppermost on the frame and the forms towards the back of the oven. If not fitted correctly the anti-tilt and safety stop mechanism will be affected.

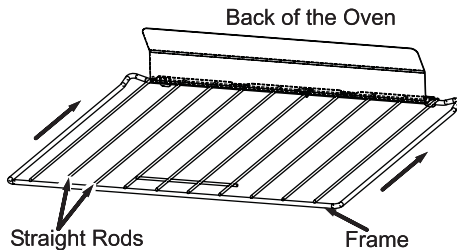

Hints and tips

- Arrange the shelves in the required positions before switching the oven on. Shelf positions are counted from the top downwards.

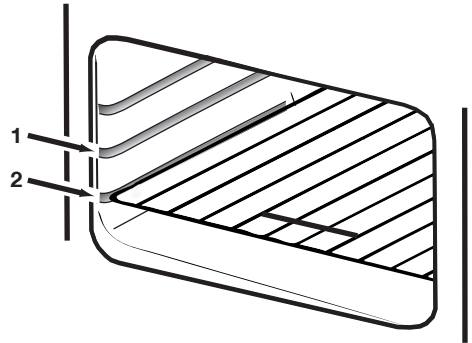

- Ensure that food is placed centrally on the shelf and there is sufficient room around the baking tray/dish to allow for maximum circulation.
- Do not push dishes too far back as food will burn if it overhangs the burner flame
- Stand dishes on a suitably sized baking tray on the shelf to prevent spillage onto the oven base and to help reduce cleaning.
- The material and finish of the baking tray and dishes used affect base browning. Enamelware, dark, heavy or non-stick utensils increase base browning. Shiny aluminium or polished steel trays reflect the heat away and give less base browning.
- Do not place baking trays directly on the oven base as it interferes with the oven air circulation and can lead to base burning; use the lower shelf position.
- For economy leave the door open for the shortest possible time, particularly when placing food into a pre-heated oven.

! WARNING!

Do not place cookware and cooking pots with rough bases e.g. cast iron on the oven door as damage to the glass may occur.

The main oven

Heat zones

There are zones of heat within the oven. The temperature in the middle is the gas mark you have chosen. The top of the oven is slightly hotter and the lower shelf slightly cooler. The base of the oven is quite a lot cooler. You can make use of these heat zones when you are cooking foods requiring different temperatures all at the same time.

If you are cooking more than one tray of similar items, for example cakes or biscuits, swap the trays during cooking or you can remove the top tray when the food is cooked and move the lower tray to the higher shelf to finish cooking.

Preheating

When you need to preheat the oven, we recommend you do so for 20 minutes.

For recipes needing high temperatures, e.g. bread, pastries, scones, soufflés etc., best results are achieved if the oven is preheated first. For best results when cooking frozen or cooked chilled ready meals always preheat the oven first.

Using the main oven

Fully open the door before lighting the main oven.

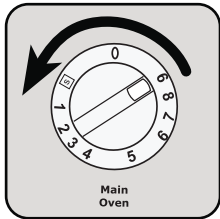

Push in the control knob and turn it to gas mark 9.

When the burner has lit release the control knob. There will only be small flames at first.

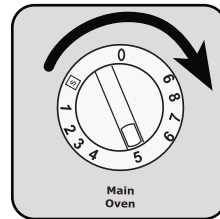

When the burner is showing large flames, adjust the setting as required.

IMPORTANT!

Do not close the door until the burner is showing large flames.

To fit the main oven shelves

The shelf should be fitted with the straight rods uppermost on the frame and the forms towards the back of the oven.

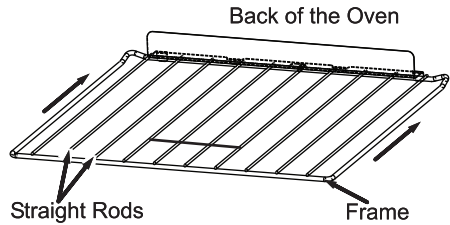

To remove a shelf slide the shelf towards you until the shelf stop is reached. Tilt shelf up at the front so that the stops clear the side supports. Lift shelf clear.

To install a shelf, reverse the above steps.

To ensure optimal performance when cooking convenience foods, pizza or frozen and chilled ready meals, always preheat the oven first.

To turn the main oven off

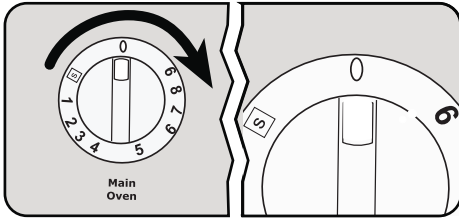

Turn the control knob to the off position. This is shown by a 0.

Things to note

- The oven light will illuminate.
- If there is an electrical power failure you cannot use the main oven.

Hints and tips

- Arrange the shelves in the required positions before switching the oven on. Shelf positions are numbered from the top downwards.

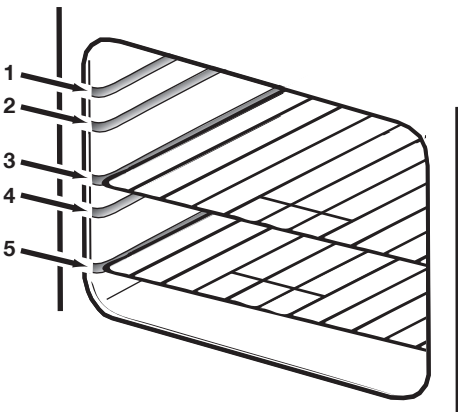

Ensure that food is placed centrally on the shelf and there is sufficient room around the baking tray/dish to allow for maximum circulation.

- Do not push dishes too far back as food will burn if it overhangs the burner flame.
- Stand dishes on a suitably sized baking tray on the shelf to prevent spillage onto the oven base and to help reduce cleaning.
- The material and finish of the baking tray and dishes used affect base browning. Enamelware, dark, heavy or non-stick utensils increase base browning. Shiny aluminium or polished steel trays reflect the heat away and give less base browning.
- When cooking more than one dish in the oven, place dishes centrally on different shelves rather than cluster several dishes on one shelf, this will allow the heat to circulate freely for the best cooking results.
- If you are cooking more than one tray of similar items, for example cakes or biscuits, swap the trays during cooking or you can remove the top tray when the food is cooked and move the lower tray to the higher shelf to finish cooking.
- Do not place baking trays directly on the oven base as it interferes with the oven air circulation and can lead to base burning; use the lower shelf position.

! WARNING!

Do not place cookware and cooking pots with rough bases e.g. cast iron on the oven door as damage to the glass may occur.

Oven cooking chart

The temperature and baking times are for guidance only, as these will depend on the consistency of the various ingredients and the number, type and size of baking tray or tins used. It may be necessary to increase or decrease the temperature to suit individual preference and requirements.

For best results, moist recipes (for example pizza, fruit flans etc) should be baked on one level. To ensure optimal performance when cooking convenience foods, pizza or frozen and chilled ready meal, always preheat the oven first.

Food	Main oven		Top oven		Approximate cook time (h)
	Gas mark	Pos	Gas mark	Pos	
Biscuits	5	2 + 4	5	1	0:10 – 0:25
Bread	8*	3	-	-	0:30 – 0:45
Bread rolls/buns	8*	3	-	-	0:10 – 0:25
Small / Queen Cakes	5	2 + 4	5	1	0:15 – 0:25
Sponges	4	2 + 4	4	1	0:18 – 0:25
Victoria Sandwich	4	2 + 4	4	1	0:20 – 0:35
Madeira Cake	4	4	4	2	1:00 – 1:30
Rich Fruit Cake	2	3	2	2	2:30 – 3:00
Christmas Cake	2	3	2	2	4:00 – 5:15
Gingerbread	2	3	2	2	1:15 – 1:45
Meringues	1	3	1	2	2:30 – 3:15
Flapjack	5	3	5	2	0:25 – 0:35
Shortbread	3	3	3	2	0:45 – 1:20
Fruit Pies, Crumbles	6	3	6	2	0:40 – 0:55
Milk Puddings	2	3	2	2	1:30 – 2:15
Scones	7	2 + 4	7	1	0:08 – 0:17

*When baking bread cook for 10 minutes at gas mark 8 then reduce to mark 6 for the remaining cook time.

Oven cooking chart continued

Food	Main oven		Top oven		Approximate cook time (h)
	Gas mark	Pos	Gas mark	Pos	
Choux Pastry	6	2	6	2	0:30 – 0:40
Éclairs / Profiteroles	5	2	5	2	0:20 – 0:35
Flaky Pastry	6	2	6	2	0:25 – 0:45
Mince Pies	5	2 + 4	5	2	0:15 – 0:25
Pasta Lasagne etc.	5	3	5	2	0:30 – 0:45
Meat Pies	7	2	7	2	0:25 – 0:40
Quiche, Tarts, Flans	5	2	5	2	0:25 – 0:50
Shepherd's Pie	7	3	7	2	0:30 – 0:45
Soufflés	5	3	5	2	0:20 – 0:35
Fish	4	2	4	2	0:20 – 0:35
Fish Pie	6	3	6	2	0:20 – 0:30
Beef Casserole	3	4	3	2	2:30 – 3:15
Lamb Casserole	3	4	3	2	2:30 – 3:15
Baked Potatoes	5	2	5	2	1:30 – 2:15
Roast Potatoes	6	2	6	1	1:00 – 1:45
Large Yorkshire Puddings:	7	1	7	1	0:25 – 0:45
Individual Yorkshire Puddings	7	1	7	1	0:15 – 0:30

Note: Shelf positions are counted from the top of the oven downwards.
To help pastry dishes brown on the underside cook on a metal plate or place on a baking tray.

Roasting chart

Meat	Gas mark	Cooking time
Beef/ Beef boned	5	20-35 minutes per ½kg (1lb) and 20-35 minutes over
Mutton/Lamb	5	25-35 minutes per ½kg (1lb) and 25-35 minutes over
Pork/Veal/Ham	5	30-40 minutes per ½kg (1lb) and 30-40 minutes over
Chicken	5	20-25 minutes per ½kg (1lb) and 20 minutes over
Turkey/Goose	5	20-25 minutes per ½kg (1lb) up to 3½kg (7lb) then 10 minutes per ½kg (1lb) over 3½kg (7lb)
Duck	5	25-35 minutes per ½kg (1lb) and 25-30 minutes over
Pheasant	5	35-40 minutes per ½kg (1lb) and 35-40 minutes over
Rabbit	5	20 minutes per ½kg (1lb) and 20 minutes over

INTERNAL TEMPERATURES –

Rare: 50-60°C; Medium: 60-70°C; Well done: 70-80°C

The roasting temperatures and times given in the chart should be adequate for most joints, but slight adjustments may be required to allow for personal requirements and the shape and texture of the meat. However, lower temperatures and longer cooking times are recommended for less tender cuts or larger joints.

Wrap joints in foil if preferred, for extra browning uncover for the last 20 – 30 min. cooking time.

Slow cook

The slow cook setting gives a very low heat in the oven. It is particularly useful when you are cooking soups, stews and casseroles because the long slow cooking will make cheaper, tougher cuts of meat more tender.

Some foods such as pastry and biscuits are not suitable for slow cooking because the temperature is too low. Cover all food during cooking to prevent it from drying out. You can uncover food for the last half hour if it is normally served golden brown.

Using slow cook

You need to cook food at gas mark 6 for 30 minutes before you turn the oven down to the slow cook setting. This makes sure that the temperature of the food gets hot enough to start the food cooking.

Fully open the door before lighting the main oven.

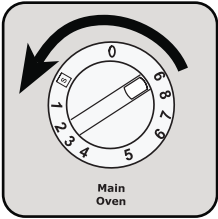

Push in the control knob and turn it to gas mark 9

When the burner has lit release the control knob. There will only be small flames at first

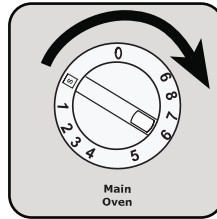

Turn the main oven control knob to gas mark 6

When the burner is showing large flames place your food in the oven and close the door.

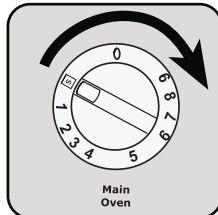

After 30 minutes turn the main oven control to the slow cook setting

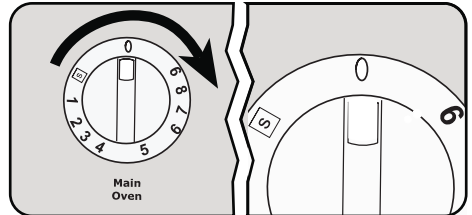

To turn the slow cook off, turn the control knob to the off position. This is shown by a 0.

IMPORTANT!

Do not close the door until the burner is showing large flames.

Food preparation – slow cooking

Joints of meat and poultry

- **Do not** cook meat joints over 2.7kg (6lb).
- **Do not** cook poultry over 2 kg (4lb 8oz).
- Cook on the middle shelf of the oven or above.
- Cook stuffing separately.
- Cook for at least six hours.
- Only cook joints of pork if you can make sure, by using a meat thermometer, that the temperature inside the joint is at least 88° C.
- For good air circulation always stand joints on a rack in a roasting tin or casserole.
- Thaw all frozen meat and poultry before you cook it.
- Prime cuts of meat do not benefit from slow cooking.
- Remove excess fat and skin unless it is browned first.

Soups, casseroles and stews

- **Do not** cook casseroles over 2.7 kg (6lb).
- Bring to the boil on the hob then cook on slow cook.
- Cook on the middle shelf of the oven or above.
- Cover food with a tight fitting lid or tin foil.

Vegetables

- Cut into small pieces.
- Dried beans must be pre-soaked then boiled in an open pan for 15 minutes before adding to any dish.
- Place vegetables under meat in casseroles.
- Cover food with a tight fitting lid or tin foil.

Milk puddings

- Cover the cereal with boiling water and leave it to stand for 30 minutes.
- Drain and make the pudding in the usual way.

General points

Frozen Foods

Thaw thoroughly before cooking.

Thickening

Toss meat in flour for casseroles.

Alternatively blend cornflour with water and add it at the end of cooking.

Flavouring

Flavours are held in the food because there is little evaporation. Adjust flavouring at the end of the cooking time.

Liquid

Use slightly less liquid as there is little evaporation during cooking. Always add milk and milk products, for example cream towards the end of cooking to prevent them from curdling.

Reheating

Cool left over food quickly and then put it in the fridge. Do not reheat food using the slow cook setting. Reheat food in the usual way or in a microwave. Only reheat food once.

Care and cleaning

WARNING!

Before cleaning always allow the appliance to cool down before switching off at the electricity supply.

Cleaning materials

- Before using any cleaning materials on your appliance, check that they are suitable and that their use is recommended by the manufacturer.
- Cleaners that contain bleach should not be used as they may dull the surface finishes. Harsh abrasives and scourers should also be avoided.

Cleaning the outside of the appliance

- Do not use abrasive cleaning materials e.g. abrasive cream cleaners, wire wool pads or scourers on painted or printed finishes as damage may occur. Regularly wipe over the control panel, control knobs, handles, doors and appliance sides using a soft cloth and hot soapy water. To prevent streaking, finish with a soft cloth.
- Stainless Steel cream cleaners are abrasive and should be avoided as they may dull the surface finish. **Any spillage on the stainless steel finish must be wiped off immediately.**

WARNING!

Do not attempt to remove any of the control knobs from the appliance as this may cause damage and is a safety hazard.

Cleaning the hob

- Clean the hob using a mild abrasive.
- Take care not to damage the spark electrodes. If the spark electrodes are damaged the burners will not light. You can remove the pan supports, burner caps and burner crowns to clean them. Again take care not to damage the spark electrodes.
- Clean the burner crowns and pan supports by soaking them in very hot soapy water.
- Aluminium based saucepans can leave shiny metal marks on the pan supports. You can remove any stubborn stains by scouring with a soap impregnated steel wool pad. If you look after the burner crowns and pan supports in this way they will stay reasonably clean. However the surface will dull with time. After cleaning the appliance parts, dry them thoroughly before you put them back.

When replacing hob burner parts

1. Crown to body. (Do not try to force the crown on to the body). Make sure that the hole in the crown is over the electrode. Check that the location pegs sit in the slots in the body. When the crown is in this position let it fall freely on to the body. Check that the crown can be moved slightly from side to side.
2. Cap to crown. Place cap centrally on the top of crown (enamel side up). Move sideways and front to back to check the cap is properly fitted.
3. Check for ignition. If a burner will not light then you need to check the crown and cap positions.

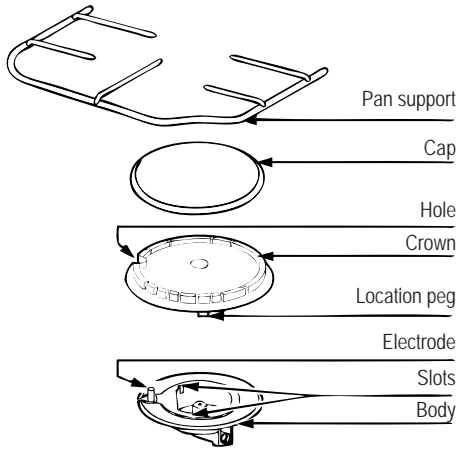

Cleaning the grill and oven furniture

All removable parts, except the grill pan handle can be washed in the dishwasher.

The grill pan, grill pan grid and oven shelves may be cleaned using a soap impregnated steel wool pad. Soaking first in hot soapy water will make cleaning easier.

Cleaning the grill

Do not clean the grill burner itself. Cleaning the grill may cause the holes in the burner to become blocked preventing it from operating correctly. Due to the nature of stainless steel the grill burner may tarnish through use over a period of time. This is quite normal and is not a fault on the appliance. Clean the area around the grill frequently using hot soapy water.

Cleaning inside the grill and oven compartments

- The sides and back of the main oven compartments are coated with a special Stay-clean coating. They should not be cleaned manually.

- The vitreous enamel main oven base and grill/top oven compartment can be cleaned using normal oven cleaners with care. Ensure that the manufacturers instructions are followed and that all parts are well rinsed afterwards.

! WARNING!

Aerosol cleaners must not come into contact with elements, the door seal, or any painted finishes as this may cause damage.

! WARNING!

Aerosol cleaners must not be used on Stay-clean surfaces.

- To carry out the cleaning cycle, remove the oven shelves and set the oven to gas mark 6.
- It is a good idea to run the oven for an hour or two per week to ensure continued good performance from the Stay-clean finish.
- Slight discolouration and polishing of the Stay-clean surfaces may occur in time. This does not affect the Stay-clean properties in any way.
- Use minimal, if any, extra oil or fat when roasting meat, potatoes only require brushing with fat before cooking. Extra fat in the oven during roasting will increase splashing and staining of the cavity.
- It is not necessary to add water to a meat tin when roasting. The water and the fat juices from the joint create excessive splattering during cooking – even at normal temperatures, as well as causing condensation.
- Covering joints during cooking will also prevent splashing onto the interior surfaces. Removing the covering for the last 20-30 minutes will allow extra browning if required. Some large joints and turkeys especially benefit by this method of cooking, allowing the joint to cook through before the outside is over-browned.

Cleaning the door(s)

! WARNING!

To prevent damaging or weakening the door glass panels avoid the use of the following:

- Household detergents and bleaches
- Soap impregnated pads unsuitable for non-stick saucepans.
- Abrasive cleaning pads, scourers and steel wool pads.
- Chemical oven pads or aerosols.
- Rust removers.
- Bath/Sink stain removers.

Cleaning between the outer and inner door glass

IMPORTANT!

The inner door glass is removable for cleaning.

IMPORTANT!

Please note that the door glass on your product may differ in type and shape from that shown in the diagrams.

To remove the inner glass

Open the oven door to gain access to the top of the oven door.

Top Oven:

- Carefully push the trim towards the oven and lift off.
- Hold the door glass securely in place with one hand before sliding the glass out with the other hand.

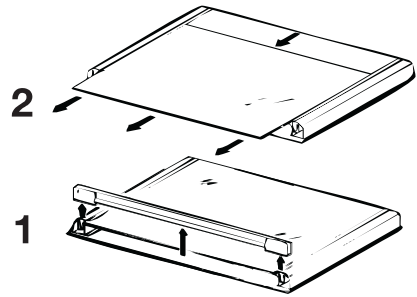

Main Oven:

- Carefully push the trim towards the oven.
- Hold the door glass securely in place with one hand before sliding the glass out with the other hand.

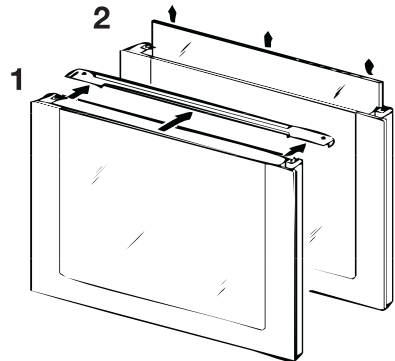

! WARNING!

If the door glass panel becomes chipped or has deep scratches the glass will be weakened and must be replaced to prevent the possibility of the panel shattering. Please contact your local service force centre who will be pleased to advise further.

To replace the inner glass

To ensure the glass is properly located the text should be facing towards you at the top edge of the door and facing into the cavity. Holding the glass with both hands, gently slide the glass into the side trims of the oven door.

Always ensure that the glass is returned to the same side trim it was removed from.

To replace the trim, line up the clips on the underside of the trim with the connectors at the top of the door.

Carefully slide the trim towards the door. Ensure the trim is securely in place before closing the oven door.

! WARNING!

Do not attempt to use the oven without the glass being in place.

To clean the inner glass door panels

Clean the inner glass door panels using hot soapy water, hob cleaner may also be used. Do not use hob cleaner on the stainless steel or painted surfaces. Ensure that all parts are well rinsed and thoroughly dried before attempting to replace the glass.

Replacing an oven light bulb

- The type of bulb required is a 300° C 25 watt small Edison Screw.

! WARNING!

Disconnect the appliance from the electricity supply before replacing the bulb.

- Make sure the appliance is cool before replacing the bulb.
- Open the door and remove the shelves.
- Remove the glass cover by turning it to the left.
- Unscrew the bulb by turning it to the left.
- Fit a new bulb and then replace the glass bulb cover.
- Refit the shelves.
- Restore the electricity supply and reset the time of day.

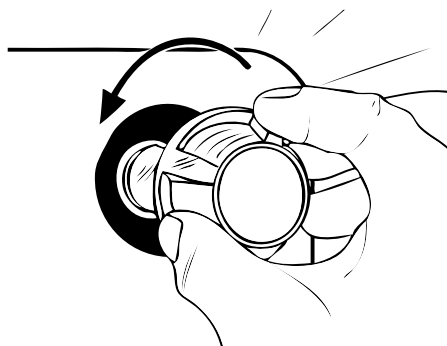

Troubleshooting

- Maintenance must only be carried out by a competent/qualified person. Do not try to alter/modify the appliance yourself, as this could be dangerous.
- We recommend that your appliance has an annual gas safety check carried out by our approved service organisation.
- Please carry out the following checks on your appliance before calling a Service Engineer. It may be that the problem is a simple one that you can solve yourself without the expense of a service call.
- **In-guarantee customers should make sure that the checks have been made as the engineer will make a charge if the fault is not a mechanical or electrical breakdown.**
- Please note that proof of purchase is required for in-guarantee service calls.

PROBLEM	POSSIBLE SOLUTION
The grill, ovens and timer do not work.	Check that the appliance has been wired in to the appliance supply and is switched on at the wall. Check that there is not a problem with your gas supply. You can do this by making sure the other gas appliances such as central heating or gas fires are working. Check that the main appliance fuse is working.
The grill and top oven work but the main oven does not.	If you have checked the above: Allow the appliance to cool for a couple of hours. The appliance should now be working normally.
The timer does not work.	Check that the time of day has been set on the clock. Check that the oven is set for manual. Check that the instructions for the operation of the timer are being closely followed.
The oven is not cooking evenly.	Check that the appliance is correctly installed and is level. Check that the recommended temperatures and shelf positions are being used.
The oven light fails to illuminate.	The oven light bulb may need replacing.
The oven temperature is too high or too low.	Check that the recommended temperatures and shelf positions are being used. Be prepared to adjust the temperature up or down slightly to achieve the results you want.

PROBLEM	POSSIBLE SOLUTION
The hob burners will not light.	Ensure the burner parts have been placed correctly.
	Check that there is not a problem with your gas supply. You can do this by making sure the other gas appliances such as central heating or gas fires are working.
The flame colour is orange/yellow.	Due to the design of the burner the flame can appear to be orange/yellow (flame disturbance) in certain areas of the burner this is a natural occurrence.
The burner is not igniting or only partially lighting.	Check that the burner is dry and that food spillage or cleaning fluids are not present on the burner. This can be dried with a cloth and stubborn marks cleaned away with a dry nylon brush (old toothbrush etc.)
The burner sounds noisy.	It is natural for the burners to emit noise as the gas is being drawn through the burner and may reduce as they heat up.
The burner is emitting a popping sound.	This is a natural occurrence when the burner is alight and does not affect the performance of the burner.
Noise.	It is normal for some metal parts on the cooker to produce noise when in use, this is due to expansion and contraction when heating up and cooling down.

Technical data

Dimensions	
Height:	900mm (nominal)
Width:	550mm (nominal)
Depth:	600mm (to front of door panel)
Weight:	58Kg
Space for fixing at hotplate level	2mm minimum clearance.
Space for fixing above hotplate level	See important note 'Location of appliance'.
Minimum space above hotplate level	650mm (If a cooker hood is fitted refer to the cookerhood installation instructions).
Minimum distance from rear wall	5mm (spacer given by pressed spacer on vent panel).
Connections	
Gas connection	Rear left hand side of appliance at hotplate level. Rc 1/2" (1/2" B.S.P. female)
Electrical connection	230V-240V a.c. 50Hz mains 3-core cable and moulded plug fuse to 3 amps.



This appliance complies with: European Council Directives Low voltage Directive 73/23/EEC, Gas Directive 90/396/EEC EMC Directive 89/336/EEC, CE Marking Directive 93/68/EEC.

Technical data

Hotplate	Natural Gas			
Heat input	R.H.F. 1.0kW (3412 Btu/h)	R.H.R. 1.9kW (6483 Btu/h)	L.H.R. 1.9kW (6483 Btu/h)	L.H.F. 2.9kW (9895 Btu/h)
Injector marking	070	096	096	119
Grill	Natural Gas			
Heat Input	2.7kW (9212 Btu/h)			
Injector marking	120			
Top oven	Natural Gas			
Heat Input	1.9kW (6483 Btu/h)			
Injector marking	099			
Dual control bypass	50			
Main oven	Natural Gas			
Heat Input	1.9kW (6483 Btu/h)			
Injector marking	099			
Thermostat bypass marking	075			
General				
Ignition	(H.T. Spark)			
Spark gap	3-4mm			
Gas category	Countries of destination			
CAT. I2H	GB			

Installation instructions

Important – safety requirements

- Natural Gas versions of this appliance are available.
- Check that this model is suitable for the type of supply available. This appliance must be installed and/or serviced by a competent person in accordance with the Gas Safety (Installation and Use) Regulations Current Editions and the I.E.E. Wiring Regulations.
- Detailed recommendations are contained in the following British Standard Codes of Practice – BS.6172, BS.5440: Part 2 and B.S.6891. All British Standards must be 'Current Editions'.



This appliance is not suitable for installation in flats or other multi occupancy dwellings as defined in clause 8.2.1 of IGE/G/5.



WARNING!

This appliance must be installed by a qualified electrician / competent person (Gas Safe Register). Safety may be impaired if installation is not carried out in accordance with these instructions. Before connecting the appliance make sure that the voltage of your electricity supply is the same as that indicated on the rating plate. This is situated on the front frame of the appliance and can be seen upon opening the door. Alternatively the rating plate may also be found on the back or top of some models (where applicable). Do not alter the electrical circuitry of this appliance.

Provision for ventilation

- This appliance is not connected to a combustion products evacuation device. It shall be installed and connected in accordance with the current installation regulations. Particular attention shall be given to the relevant requirements regarding ventilation.
- The room containing the appliance should have an air supply in accordance with BS.5440: Part 2 Current Edition. All rooms require an openable window or equivalent and some rooms will require a permanent vent as well. For room volumes up to 5m³ an air vent of 100cm² is required: for room volumes between 5m³ and 10m³ an air vent of 50cm² is required. If the room has a door that opens directly to the outside, no air vent is required. For room volumes that exceed 11m³ no air vent is required. If there are other fuel burning appliances in the same room, BS.5440: Part 2 Current Edition should be consulted to determine the requisite air vent requirements.
- Prolonged intensive use of the appliance may call for additional ventilation, for example opening a window, or more effective ventilation, for example increasing the level of mechanical ventilation where present.

Moving your appliance

- You may damage some soft or badly fitted floor coverings when you move the appliance. The floor covering under the appliance should be securely fixed so it does not ruck up when you move the appliance across it. Alternatively you could remove the floor covering. This appliance is heavy and care must be taken when moving it. Do not try to move the appliance by pulling the door handles.
- To move the appliance, open the grill door. Raise the appliance off its front feet by lifting it from inside the oven. Pull the appliance forward. When you replace the appliance push it back to the stop and make sure there is the same gap at each rear corner.

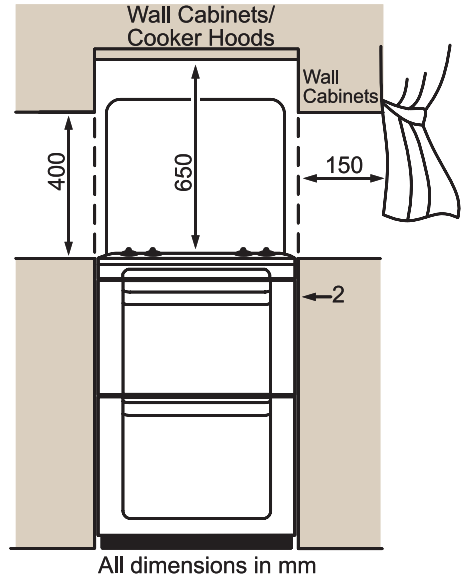

For your safety

- Do not try to disconnect the appliance from the gas supply if the supply pipe does not have a bayonet connection, as described in the installation instructions. If this is the case contact the person who installed the appliance.
- Shelves, wall cabinets and cooker hoods must be fitted a minimum of 650mm directly above the top of the hob (or greater for cooker hoods if recommended by manufacturers instructions) and 400mm above the hob when fitted in line with the outside of the appliance. If the units are intended to be fitted adjacent to the appliance but less than 400mm above the hob, then a minimum space of 50mm must be maintained between the sides of the unit and the appliance.

Location of appliance

- This appliance must not be installed in a bed-sitting room of volume less than 20m³ or in a bathroom, shower room or garage. It is essential that the appliance is positioned as shown.

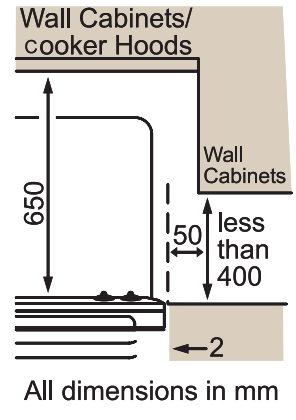

- Curtains must not be fitted immediately behind the appliance or within 150mm of the sides of the hob. If fitted next to or between two base units a minimum space of 2mm must be left between each unit and the sides of the appliance. The levelling feet fitted to the appliance will achieve a nominal height to hob of 907mm +/- 5mm

Leveling the appliance

- Adjustment to suit floor conditions or height is obtained by rotating clockwise or anti clockwise the feet at the front and rear of the appliance. A spirit level should be placed on one of the shelves to confirm the appliance is correctly leveled.

Connecting to electricity supply

! WARNING!

This appliance must be earthed.

Do not earth this appliance to the gas supply piping.

Connect to 230-240 A.C supply only.

- Connection to the electricity supply should be made via a properly earthed, readily accessible wall socket. Which is adjacent to, but not directly above and not more than 1.7m away from the appliance and capable of electrical isolation. The cooker point should be within 1.7m of the appliance to make it accessible to switch off the appliance in case of emergency. The mains lead should be routed so that it cannot touch hot parts of the cooker i.e. the back panel above a height of 650mm from the floor.
- Should this plug not fit the socket outlet in your home it should be cut off and replaced with a suitable plug as outlined below.

- **If the moulded plug is cut from the cable for any reason it must be destroyed or disposed of safely, as protruding wires will be an electrical shock hazard.**

If the fitted plug is removed.

- The flexible mains lead must be correctly connected as below to three-pin plug of not less than 13amp capacity. If a B.S. 1363 fused plug is used, it must be fitted with a 3-amp fuse, which is approved to B.S. 1362.

IMPORTANT!

The wires in the mains lead fitted to the appliance are coloured in accordance with the following code.

Green and yellow -Earth

Blue -Neutral

Brown -Live

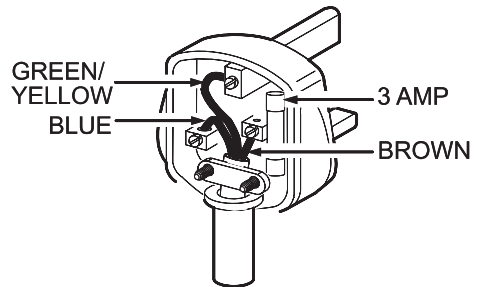

- As the colours of the wires in the mains lead of this appliance may not correspond with the coloured markings identifying the terminals in your plug, proceed as follows: -
- The wire, which is, coloured green and yellow must be connected to the terminals in the plug, which is marked with the letter E or by the earth symbol (⊕) or coloured green or green and yellow.

- The wire, which is coloured blue, must be connected to the terminal, which is marked with the letter N or coloured black.
- The wire, which is coloured brown, must be connected to the terminal, which is marked with the letter L or coloured red.
- Ensure that the cable does not become trapped when pushing the appliance into position.

If a moulded plug is fitted.

- In the event of replacing a fuse in the plug supplied a 3 amp ASTA approved fuse to B.S. 1362 must be fitted.

IMPORTANT!

The fuse cover must be refitted when changing the fuse. In the event of losing the fuse cover the plug must not be used until a replacement fuse cover has been obtained and fitted.

Connecting to gas supply

- This appliance is designed to be installed with an appliance flexible connection only.
- Supply piping should not be less than R₃/8. Connection is made to the Rc ½ (½" B.S.P.) female threaded entry pipe located just below the hob level on the rear left hand side of the appliance.

IMPORTANT!

ONLY LIQUID SEALANTS TO BE USED WHEN INLET GAS PIPE IS FITTED I.E.: DO NOT USE P.T.F.E. SEALANT TAPE.

- Carry out a gas tightness test after connecting to the gas supply.
- The gas bayonet connector must be fitted in the shaded area indicated.

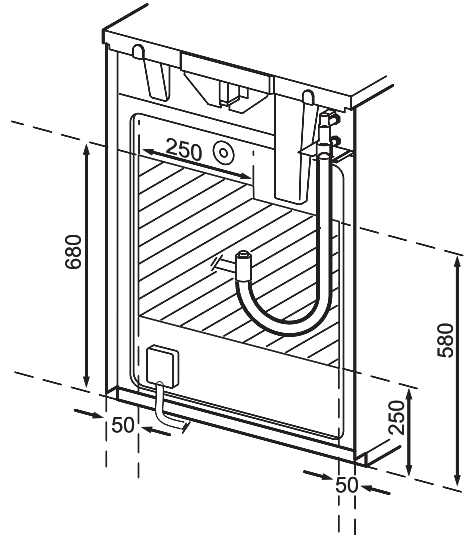

- Take into account that it must be possible to pull the appliance forward sufficiently. Ensure the hose does not become trapped when pushing the appliance into position.

IMPORTANT!

FLEXIBLE TUBING USED MUST COMPLY WITH BS.669 CURRENT EDITION.

Fitting the stability chain

It is recommended that if the appliance is to be installed with a flexible supply pipe, a stability chain be fitted and is available from your supplier (see Important Safety Requirements). These instructions should be read in conjunction with any leaflet packed with the stability chain.

1. Place the appliance in its intended position and level appliance.
2. Mark a position 100mm from the top of the rear right hand corner.
3. Measure down 150mm from this point. This gives the position of the wall anchor point for the stability chain.

- The stability chain anchor point on the appliance is shown below.

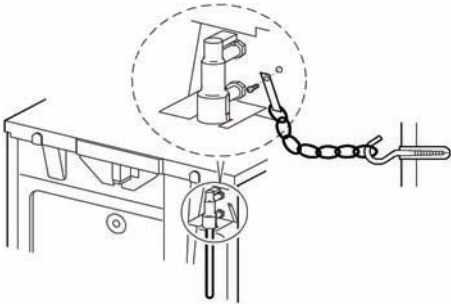

Pressure testing

- The Rapid injector is used as a pressure test point.
- Connect the pressure gauge to the Rapid injector.
- Check the supply pressure by turning the Rapid burner on and one other hotplate burner full on and light the appropriate burner. The pressure should be 20mbar.
- Turn off the taps, disconnect the pressure gauge.
- Check operation of each hotplate burner.

Checking the grill

- Place the grill pan containing the grid, with the handle attached, into the grill compartment. Light the grill burner by turning the grill tap full on and pressing the ignition button on the fascia panel. As soon as the burner is lit the button can be released.

Checking the hob

- Lift the lid. Fit the burner crowns and caps ensuring that they are correctly seated. Fit the pan supports.
- Check each of the hob burners in turn by turning the hob tap to its full on position and pressing the ignition button. As soon as the burners are lit the button can be released.

Checking the lid shut-off device

- Lift the lid
- Turn one hotplate tap to its full on position and push the ignition button.
- Close the lid. There should now be no gas supply to the hotplate and the burner will go out.
- Turn off the hotplate and lift the lid. The gas supply should now be restored to the hotplate, when the tap is turned on.

Checking the top oven

- Turn the top oven thermostat control knob to Mk.9 and press the ignition button. As soon as the burner is alight the button can be released.
- After 1 minute check that the flame covers the full width of the burner and is stable.
- Set the oven control to Mk. 2, close the oven door and check that after about 10 minutes the flame size has reduced.
- Turn off the control knob and check that the oven flames go out.

Checking the main oven

1. Turn on the oven thermostat control knob to mark 9. As soon as the burner is alight the control can be released.
2. There should now be a low gas rate to the burner, which is the F.S.D bypass rate.
3. When the F.S.D. phial has heated up it opens the F.S.D valve, which allows the main gas supply to the oven burner.
4. After 1 minute check that the flame covers the full width of the burner and is stable.
5. Set the oven control to Mk 2, close the oven door and check that after about 10 minutes the flame size has reduced.
6. Turn off the control and check that the oven flames go out.

Checking the main oven light

- Turn the main oven thermostat knob full on and check that the main oven light is operative. Turn off the thermostat.

To set the time of day

- Please refer to the Timer section.

General note

- Instruct the user on how to use the appliance and its ignition system. Refer the user to the wording inside this manual which gives advice on the safe operation of the appliance.

Environment



After installation please dispose of the packaging with due regard for safety and the environment. Your local authority can arrange this.

Energy save mode

By switching off the time display you can save energy.

Switching off the time display

Press and hold any two buttons until the display switches off.

Switching on the time display

Press any button to switch on the display.

IMPORTANT!

The display can only be switched off if none of the timer functions are in use.



At the end of the appliances life

The symbol  on the product or on its packaging indicates that this product may not be treated as household waste. Instead it shall be handed over to the applicable collection point for the recycling of electrical and electronic equipment. By ensuring this product is disposed of correctly, you will help prevent potential negative consequences for the environment and human health, which could otherwise be caused by inappropriate waste handling of this product. For more detailed information about recycling of this product, please contact your local city office, your household waste disposal service or the shop where you purchased the product.

Guarantee / Customer care

Standard guarantee conditions

We, Electrolux, undertake that if within 12 months of the date of the purchase this Electrolux appliance or any part thereof is proved to be defective by reason only of faulty workmanship or materials, we will, at our option repair or replace the same FREE OF CHARGE for labour, materials or carriage on condition that:

- The appliance has been correctly installed and used only on the electricity supply stated on the rating plate.
- The appliance has been used for normal domestic purposes only, and in accordance with the manufacturer's instructions.
- The appliance has not been serviced, maintained, repaired, taken apart or tampered with by any person not authorised by us.
- Electrolux Service Force Centre must undertake all service work under this guarantee
- Any appliance or defective part replaced shall become the Company's property.
- This guarantee is in addition to your statutory and other legal rights.

Exclusions

- Damage or calls resulting from transportation, improper use or neglect, the replacement of any light bulbs or removable parts of glass or plastic.
- Costs incurred for calls to put right an appliance which is improperly installed or calls to appliances outside the United Kingdom.
- Appliances found to be in use within a commercial environment, plus those which are subject to rental agreements.
- Products of Electrolux manufacturer that are not marketed by Electrolux

Service and Spare Parts

In the event of your appliance requiring service, or if you wish to purchase spare parts, please contact your local Service Force Centre by telephoning

0870 5 929 929

Your telephone call will be automatically routed to the Service Force Centre covering your postcode area. For the address of your local Service Force Centre and further information about Service Force, please visit the website at

www.serviceforce.co.uk

Before calling out an engineer, please ensure you have read the details under the heading "Something not working"

When you contact the Service Force Centre you will need to give the following details:

1. Your name, address and postcode.
2. Your telephone number.
3. Clear concise details of the fault.
4. The model and Serial number of the appliance (found on the rating plate).
5. The purchase date.

Please note a valid purchase receipt or guarantee documentation is required for in guarantee service calls.

Customer Care

For general enquiries concerning your Electrolux appliance, or for further information on Electrolux products please contact our Customer Care Department by letter or telephone at the address below or visit our website at www.electrolux.co.uk

Customer Care Department
Electrolux Major Appliances
Addington Way
Luton
Bedfordshire, LU4 9QQ
Tel: 08705 950 950 (*)

(*) Calls may be recorded for training purposes



Notes

Notes

www.electrolux.com

www.zanussi-electrolux.co.uk