

Slide In Dual Fuel

**500mm, 550mm & 600mm wide
Freestanding Cookers with
Electric Double Oven & Grill and Gas Hotplate**
for Natural Gas models and LP Gas models

User & Installation Instructions

STOVES™

Stoney Lane, Prescott, Merseyside, L35 2XW

If you smell gas:

Do not try to light any appliance. Do not touch any electrical switch.

Call the Gas Emergency Helpline at TRANSCO on: **0800 111999**

In the Republic of Ireland, call the Bord Gáis emergency line on **1850 205050** or contact your local gas supplier.

Stoves Customer Care

In case of difficulty within the UK and Northern Ireland, please call STOVES Customer Care Centre Helpline on

0151 432 7838

When you dial this number you will hear a recorded message and be given a number of options. This indicates that your call has been accepted and is being held in a queue. Calls are answered in strict rotation as our Customer Care Representatives become available.

Opening Hours for Customer Care Centre

Monday to Friday	8am - 8pm
Saturday	8.30am - 6pm
Sunday	10am - 4pm

Enter appliance numbers here for future reference:

Model No
<input type="text"/>
Serial No
<input type="text"/>

Please ensure you have the above details (Model No and Serial No) to hand when calling Stoves Customer Care. They are essential to booking your call.

Outside the UK and Northern Ireland, refer to your local supplier.

The Gas Consumer Council (GCC) is an independent organisation which protects the interests of gas users. If you need advice, you will find the telephone number in your local telephone directory under Gas.

The appliance must be installed (and serviced) by a Corgi registered approved installer or a person competent to ensure that the installation is in accordance with "The Gas Safety (Installation and Use) Regulations 1994", and the "The Gas Safety (Installation and Use) (Amendment) Regulations 1996". Failure to comply with these Regulations is a criminal offence.



Technical Data

Data badge; On the bottom of the front frame behind the oven door.

Type of gas; This cooker must only be used with either Natural Gas only or LP Gas only, as specified on the appliance data badge.

Gas category; Natural Gas - I2H, LP Gas - I3+

Pressure setting

G20 Natural Gas @ 20 mbar

G30 Butane @ 28 - 30 mbar

G31 Propane @ 37 mbar

Pressure test point; Use the oven injector

Aeration; Fixed

Electrical supply; 220 - 240V ~ 50Hz

Spark generator; Mains operated 6 outlet controlled by a single rocker switch at the LHS of the fascia to individual electrodes. 2 outlets shorted to earth.

Warning; This cooker must be earthed.

Hob - Burners have burner heads and caps which are removable for cleaning. Concealed electrodes to each burner.

Appliance class; Class 1, freestanding

Countries of destination; GB - Great Britain, IE - Ireland

Type	Oven Light	Max Load
500 single grill	0	3435W
500 single grill	1	3460W
500 single grill	2	3485W
550/600 single grill	0	4165W
550/600 single grill	1	4190W
550/600 single grill	2	4215W
550/600 dual grill	0	5125W
550/600 dual grill	1	5150W
550/600 dual grill	2	5175W

Fuel	Burner / Element	Nominal Rate Qn	Injector Size	Grammes per hour	
				Butane	Propane
Natural Gas	Hob - LHF	1.0kW	77	-	-
	Hob - LHR & RHR	2.0kW	104	-	-
	Hob - RHF	3.0kW	130	-	-
	Total heat input	∑Qn 8.0kW	-	-	-
LP Gas	Hob - LHF	1.0kW	50	73 g/h	71 g/h
	Hob - LHR & RHR	2.0kW	70	145 g/h	143 g/h
	Hob - RHF	3.0kW	87	218 g/h	214 g/h
	Total heat input	∑Qn 8.0kW	-	581 g/h	571 g/h
Electric @ 230V	Main oven (500)	1670W	-	-	-
	Main oven (550/600)	2400W	-	-	-
	Top oven (500)	1245W	-	-	-
	Top oven (550/600)	1285W	-	-	-
	Grill	1725W	-	-	-
	Dual grill	2685W	-	-	-
	Stir fan	30W	-	-	-
	Cooling fan	10W	-	-	-
Oven light	25W	-	-	-	

Contents

User's Section	2 - 17
Introduction	2
Be Safe - Not Sorry.	4
Using the Hob	5
Using the Grill	7
Using the Top Oven	9
Top oven baking guide	10
Using the Main Oven	11
Baking guide	13
Slow cooking	13
Traditional fruit cakes	14
Roasting turkey.	14
Roasting guide	15
Minute Minder (if fitted)	16
Cleaning	17
 Installation Instructions.	 19 - 23
 Technical Data	 21
 Stoves Customer Care	 24

Please keep this handbook for future reference, or for anyone else who may use the appliance.

Introduction

Thank you for choosing a British built appliance by Stoves

We hope that the following information will help you to familiarise yourself with the features of the appliance, and to use it successfully and safely.

Our policy is one of constant development & improvement. Strict accuracy of illustrations and specifications is not guaranteed. Modification to design and materials may be necessary subsequent to publication.

This appliance must be installed in accordance with the regulations in force, and only in a well ventilated space. Read the instructions before installing or using this appliance.

Your new appliance is designed to be installed flush to base units.

Your 1st Year Guarantee

To fulfil the conditions of your guarantee, this appliance must be correctly installed and operated, in accordance with these instructions, and only be used for normal domestic purposes.

Please note that the guarantee, and Service availability, only apply to the UK and Republic of Ireland.

Before using the appliance for the first time, remove any protective polythene film and wash the oven shelves in hot soapy water, to remove their protective coating of oil. Even so, when you first turn on the oven or grill you may notice a smell and some smoke.

Gas & Electrical connection

Please refer to installation instructions for the Gas & Electrical Safety Regulations and the Ventilation Requirements.

In your own interest, and that of safety, it is the law that all gas appliances be installed by competent persons, who will ensure that the installation is in accordance with "The Gas Safety (Installation and Use) Regulations 1994", and the "The Gas Safety (Installation and Use) (Amendment) Regulations 1996". Failure to comply with these Regulations is a criminal offence. Corgi registered installers undertake to work to satisfactory standards.

Disconnection of gas and electric appliances should always be carried out by competent persons.

Warning: This appliance must be earthed.

Stability bracket

If the cooker is to be fitted with a flexible inlet connection, a stability bracket should also be fitted to engage in the back of the cooker. Make sure this is re-engaged whenever you move the cooker for cleaning.

Installation Instructions

Commissioning

Burner aeration

All burners have fixed aeration and no adjustment is possible.

Pressure setting

G20 Natural Gas @ 20 mbar

G30 Butane @ 28-30 mbar

G31 Propane @ 37 mbar

Pressure test point

Use the hotplate injector

Hob - Turn the control knob to the FULL ON position, wait a second before pressing the ignition switch or holding a lighted match or taper to the burner.

Before leaving the installation

1. Place all the loose parts of the cooker into position.
2. Show the customer how to operate the cooker and give them this handbook. Thank you.

Installation Instructions

Connect to the gas supply

The inlet to the cooker is ½" BSP internal situated at the rear right corner. Fit the bayonet connection. This should be located so as to ensure that the flexible connector hose does not kink. Use a 900 - 1125mm length of flexible connector.

Ensure that all pipe work is of the correct rating for both size and temperature.

Natural Gas - Flexible connections should comply with BS669. Parts of the appliance likely to come into contact with a flexible connector have a temperature rise of less than 70°C.

LP Gas - For flexible connections use a bayonet type hose, suitable for use on LP Gas up to 50 mbar pressure rise and 70°C temperature rise. The flexible hose should be coloured black with a red stripe, band or label. If in doubt, contact your supplier.

After installation, make sure all connections are gas sound.

Connect to the electricity supply

Warning: This appliance must be earthed. The appliance must be installed by a competent electrician using a double pole control unit of 30 ampere minimum capacity with 3mm minimum contact separation at all poles.

We recommend that the appliance is connected by a qualified electrician who is a member of the N.I.C.E.I.C. and who will comply with the I.E.E. and local regulation.

1. Access to the mains terminal is gained by opening the terminal block cover at the rear of the appliance (use a small flat-bladed screwdriver).
2. Connection should be made with 2.5mm² twin and earth cable.
3. First strip the wires, then push the cable through the cable clamp in the terminal block cover.
4. Connect the cable to the terminal block and tighten the cable clamp screw (see diagram).
5. Close the terminal box, ensuring that the cover is engaged on the locking tabs.

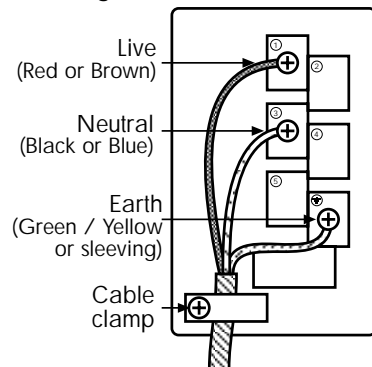

Introduction

Ventilation

The use of a gas cooking appliance results in the production of heat and moisture in the room in which it is installed. Ensure that the kitchen is well ventilated: keep natural ventilation holes open or install a mechanical ventilation device (mechanical extractor hood). Prolonged intensive use of the appliance may call for additional ventilation, for example, opening of a window, or more effective ventilation, for example increasing the level of mechanical ventilation where present.

Moving the cooker

Do not attempt to move the cooker by pulling on the doors or handles. Open the door and grasp the frame of the cooker, taking care that the door does not shut on your fingers.

Take care to avoid damage to soft or uneven floor coverings when moving the appliance. Some cushioned vinyl floor coverings may not be designed to withstand sliding appliances without marking or damage.

If the ignition fails:

- Check there is a spark when the ignition button is depressed. If there is no spark, check that the electricity supply is switched on at the cooker control box.
- Check that the gas supply is switched on.

To replace a light bulb (if fitted)

Caution: Switch off the electricity supply to the cooker at the socket, to avoid the risk of electric shock. Wait until the oven is cool, then remove the oven shelves.

Grasp the lens cover on the light fitting and pull it away from the side of the oven. Unscrew the bulb.

Please note that the oven light bulb is not covered by the guarantee. Replacement bulbs can be ordered from your local supplier, or bought from a hardware store.

Environmental Protection

We are committed to protecting the environment and operate an Environmental Management System which complies with BS EN ISO 14001:1996.

Disposal of packaging

- All our packaging materials are recyclable and environmentally friendly.
- Please help us to protect our environment by disposing of all packaging in an environmentally friendly manner.
- Please contact your local authority for the nearest recycling centre.

Caution: Packaging materials can pose a risk of suffocation - keep away from children.

Be Safe - Not Sorry

When you are cooking, keep children away from the vicinity of the appliance.

This product is designed as a domestic cooking appliance for the preparation and cooking of domestic food products, and should not be used for any other purpose.

- Remove all packaging, protective films and oils from the appliance before using for the first time.
- Make sure you read and understand the instructions before using the appliance.
- Keep electrical leads short so they do not drape over the appliance or the edge of the worktop.
- Keep all flammable materials (such as curtains, furnishings & clothing) away from the appliance.
- Parts of the appliance may be hot during or immediately after use. Care should be taken to avoid touching heating elements inside the oven.
- Never use the appliance for heating a room.
- Do not drape tea towels over the flue vents or doors, as this creates a fire hazard.
- When opening the appliance door, take care to avoid skin contact with any steam which may escape from the cooking.

- Do not use aluminium foil to cover the grill pan, or put items wrapped in foil under the grill as this creates a fire hazard. The high reflectivity can also damage the element.
- Do not use the oven with the door inner glass panel removed (glass oven doors only).
- Use oven gloves when removing hot food / dishes from the oven or grill. The oven / grill and utensils will be very hot when in use.
- Do not use foil on oven shelves, or allow it to block the oven flue, as this creates a fire hazard, and prevents heat circulation.
- When cooking heavy items - eg; turkeys - do not pull the oven shelf out with the item still on the shelf.
- Switch off the electricity supply before replacing the oven light bulb (if fitted), to avoid the risk of electric shock.

Warning: This appliance must be earthed.

When you have finished cooking check that all controls are in the off position.

Installation Instructions

Stability bracket

If the cooker is fitted with a flexible connection, a stability bracket should be fitted to engage in the back of the cooker. A stability bracket can be bought from your local supplier.

A stability bracket can be fitted as follows:

1. Place the cooker in position and draw a PENCIL LINE level with the front edge.
2. Mark the centre of the cooker to give the CENTRE LINE for the bracket.
3. Remove the cooker and mark off 450mm from the PENCIL LINE to locate the front edge of the lower bracket.

4. Fix the bracket to the floor.
Measure from FLOOR LEVEL to ENGAGEMENT EDGE in the back of the cooker and add 3mm.
5. Assemble the underside of the top part of the bracket to this height.

Levelling

Place a spirit level of a baking sheet onto an oven shelf.

The cooker is fitted with levelling feet and locknuts at the FRONT, and levelling feet only at the rear.

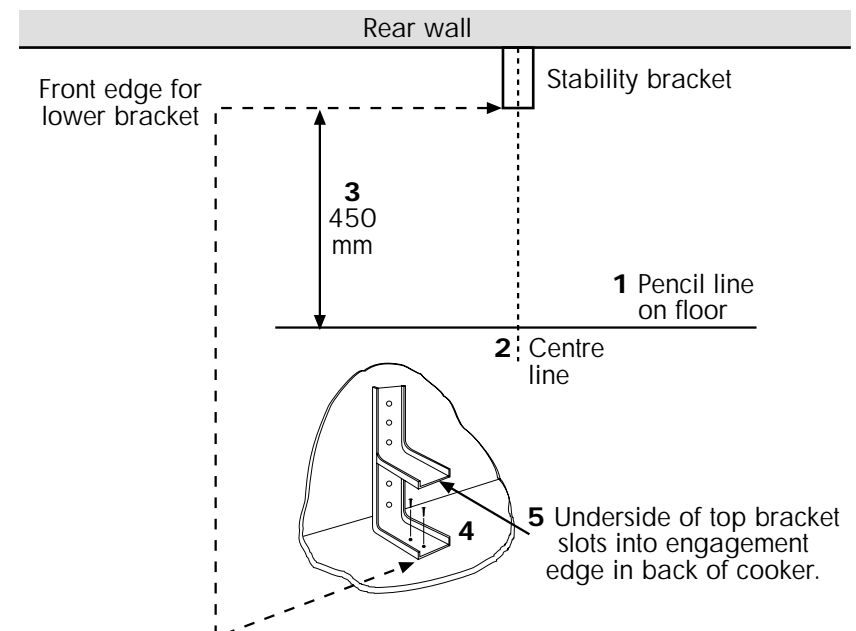

Installation Instructions

This is a type X appliance regarding installation requirements.

Important: Ensure that you route all mains cables well clear of any adjacent heat source.

Clearances

This cooker may be fitted flush to base units. However, for models with side opening doors, we recommend a side clearance of 60mm between the cooker and any side wall to allow the door to be opened fully.

No shelf or overhang or cooker hood shall be closer than a minimum of 650mm, but check with cooker hood manufacturer's recommendations.

The cooker must have a side clearance above hob level of 90mm up to a height of 400mm.

Dimensions

All sizes are nominal, and some variation is to be expected. The 'depth' of the cooker, as given below, is to the front of the door and excluding knobs and handles.

Width: 500mm, 550mm or 600mm

Depth: 600mm

Height (adjustable): 900 - 915mm

Moving the cooker

Please note that the weight of this appliance is approximately **60kg** (unpacked).

Take care if the appliance needs to be lifted during installation - always use an appropriate method of lifting.

Do not attempt to move the cooker by pulling on the doors or handles. Open the door and grasp the frame of the cooker, taking care that the door does not shut on your fingers.

Take care to avoid damage to soft or uneven floor coverings when moving the appliance. Some cushioned vinyl floor coverings may not be designed to withstand sliding appliances without marking or damage.

Using the Hob

Ignition

Push in and turn the selected control knob anticlockwise to the 'full on' position and press the ignition switch (if fitted), or hold a lighted match or taper to the burner, until the burner lights. Turn the control knob to the required setting.

Adjust the burner flame so that it does not extend over the pan base.

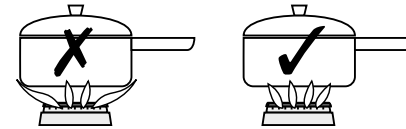

To turn off, push in the control knob and turn clockwise until the dot on the control knob is below the dot on the fascia panel.

To simmer

The simmer position is marked by the *small flame* symbol.

Once lit turn the selected control knob anticlockwise past the *large flame* symbol (FULL ON) to the *small flame* symbol.

You may hear a slight popping noise when the hob burners are operating and this is quite normal, but if anything about the cooker appears unusual, such as change in flame appearance, or the operation of controls - seek expert advice.

Pans

For optimum safety and performance, we recommend the use of flat bottomed pans with a base diameter of minimum 100mm (4") and maximum 250mm (10").

Do not use double pans, rim based pans, old misshapen pans or any pan which is unstable when placed on a flat surface.

Position pans over the centre of the burners, resting on the pan supports. If positioned off centre, smaller pans may be unstable.

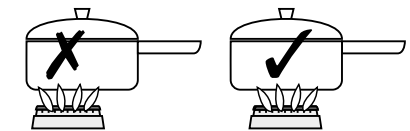

When cooking with fat or oil, never leave unattended.

Turn pan handles to a safe position, so they are out of reach of children, not overhanging the appliance, and cannot be caught accidentally.

Commercial simmering aids should not be used as they create excessive temperatures that can damage the surface and may cause a hazard.

Pan supports

Always make sure the pan supports are replaced correctly, and located in the hob spillage well.

Using the Hob

To save gas

- Use the size of pan most suited to the size of the burner - ie; larger pans on the larger burners, smaller pans on the smaller burners.
- Adjust the flames so that they do not lick up the sides of the pan.
- Put lids on saucepans and only heat the amount of liquid you need.
- When liquids boil, reduce the control setting to maintain a simmer.
- Consider the use of a pressure cooker for the cooking of a complete meal.
- Potatoes and vegetables will cook quicker if chopped into smaller pieces.

The fold down lid (if fitted)

Caution: Glass lids may shatter when heated. Turn off all the burners before shutting the lid.

When opening and closing the lid, use the cooler outer sides of the lid trim.

The lid must be opened fully, so there is no danger of it closing while the hob is being used.

The appliance is fitted with a switch-back system, which will automatically turn off the hotplate controls if they are inadvertently left on as the lid is closed.

The lid is not intended to be used as a work surface, as it becomes hot when any part of the cooker is in use, and the surface may be scratched if items with rough or sharp surfaces are placed on it.

Installation Instructions

Before you start: Please read the instructions. Planning your installation will save you time and effort.

Prior to installation, ensure that the local distribution conditions (nature of the gas and gas pressure) and the adjustment of the appliance are compatible. The adjustment conditions are stated on the data badge.

This appliance is not connected to a combustion evacuation device. It shall be installed and connected in accordance with current installation regulation. Particular attention shall be given to the relevant requirements regarding ventilation.

In your own interest and that of safety, it is the law that all gas appliances be installed and serviced by competent persons. CORGI registered installers undertake to work to satisfactory standards.

Where regulations or standards have been revised since this handbook was printed, always use the latest edition.

In the UK the regulations and standards are as follows:

1. Gas Safety Regulations 1996 (Installation and Use).
2. Building Regulations - Issued by the Department of the Environment.
3. Building Standards (Scotland) (Consolidated) - Issued by the Scottish Development Department.
4. The current I.E.E. Wiring Regulations.
5. Electricity at Work Regulations 1989.
6. BS 6172 Installation of Domestic Gas cooking Appliances
Also, for **LP Gas**, refer to BS 5482 Part 1, Part 2 or part 3 as relevant.
7. Installation & Servicing Instructions for this appliance.

For installation in countries other than the UK, the appliance must be connected in accordance with all local gas and electrical regulations. In the Republic of Ireland, Installers should refer to IS813 Domestic Gas Appliances.

Ventilation Requirements

The room containing the appliance should have an air supply in accordance with BS 5440: Part 2: 1989:

- All rooms require an openable window, or equivalent, and some rooms will require a permanent vent as well.
- For room volumes up to 5m³ an air vent of 100cm² is required.
- If the room has a door that opens directly to the outside, or the room exceeds 10m³, NO AIR VENT is required.
- For room volumes between 5m³ and 10m³ an air vent of 50cm² is required.
- If there are other fuel burning appliances in the same room, BS 5440: Part 2: 1989 should be consulted to determine the air vent requirements.
- This appliance must not be installed in a bed sitting room of less than 20m³ or in a bathroom or shower room.

Windows and permanent vents should therefore not be blocked or removed without first consulting a CORGI gas installer.

LP Gas only - Do not install this appliance in a room below ground level. This does not preclude installation into rooms which are basements with respect to one side of the building, but open to ground level on the opposite side.

In the Republic of Ireland, refer to relevant Irish Standards for correct ventilation requirements.

Failure to install appliances correctly is dangerous and could lead to prosecution.

Cleaning

Easy care surfaces

MAIN OVEN SIDES AND BACK

We recommend that the appliance is cleaned after open roasting, and also after roasting at temperatures higher than 200°C, to help prevent a build up of fats. Use of a trivet in a roasting tin when roasting will help reduce fat splashing.

Caution: Most types of cleaning agent will damage these surfaces.

Only use a few drops of washing up liquid in hot water. Wipe the surfaces with a clean cloth wrung out in hot soapy water - if larger splashes of fat do not readily disappear, scrub the area with a nylon brush or nylon pan scourer and hot soapy water. Rinse well and heat the oven to dry the surfaces.

Vitreous Enamel parts

GRILL PAN, HOB TOP & PAN SUPPORTS, OVEN COMPARTMENT FLOOR, OVEN COMPARTMENT (WIPE-CLEAN OVENS)

Use a mild cream cleaner - eg; "Cif". Stubborn marks may be removed with a moistened "Brillo" pad.

The pan supports and grill pan may be cleaned in a dishwasher, or with a nylon brush in hot soapy water.

Glass parts (if fitted)

GLASS DOOR PANELS, LID GLASS

Do not use abrasives or polishes as they will scratch and damage the glass.

Use a mild cream cleaner - eg; "Cif". Rinse away excess cleaner and dry with a soft cloth.

Warning: Do not operate the appliance without the glass panel correctly fitted.

Important: the inner door glass panel can be removed for cleaning but it must be replaced the right way up (so the reflective side - if fitted - faces inwards), and pushed fully in to the **stop** position. To remove the glass panel, open the door wide, hold the top and bottom edges and slide out.

Chrome plated parts

OVEN SHELF & SHELF RUNNERS (IF FITTED), GRILL PAN RUNNERS, GRILL PAN TRIVET

Do not use abrasives or polishes, use a moist soap pad - eg; "Brillo".

Note: Oven shelf runners can be removed for cleaning. Grasp the runners, and slide out of the hanging holes as shown.

Note: These items may also be cleaned in a dishwasher.

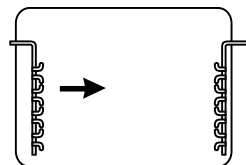

Using the Grill

Caution: Accessible parts may be hot when grill is used, young children should be kept away.

To switch on the grill

Open the grill door.

Models with single fixed grill - turn the top oven control knob to the grill symbol.

Models with dual fixed grill - turn the top oven control knob to the single grill symbol or dual grill symbol. The grill door must be **fully open** when grill is used.

To switch off, return the control knob to the "off" position.

Preheating

Always preheat the grill for about 3 minutes for best cooked results.

Aluminium foil

Using aluminium foil to cover the grill pan, or putting items wrapped in foil under the grill creates a fire hazard, and the high reflectivity may damage the grill element.

The cooling fan

When the grill is switched on, you will hear the cooling fan come on - this keeps the fans and control knobs of the appliance cool during grilling only. The fan will continue to operate for a period after the grill control has been switched off.

Should any fault occur with the cooling fan, the appliance will require servicing contact customer support.

handle handle position
Detachable grill pan handle

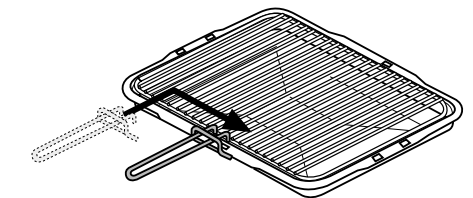
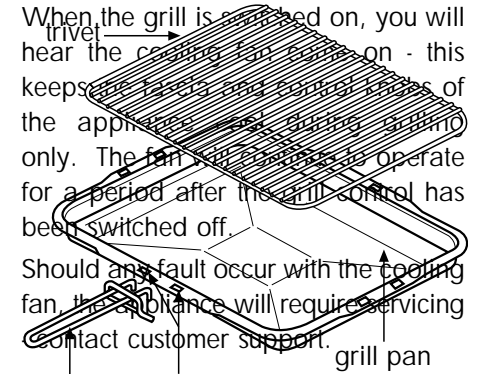

Place the handle over the edge of the grill pan, at the narrow side edges. Slide the handle to the centre, and locate between the handle position indicators.

Using the Grill

Grilling

Push the grill pan towards the back of the shelf, to position it under the grill.

The grill setting can be adjusted by turning the grill control to either the dual or single grill symbol.

The speed of grilling can also be controlled by selecting a higher or lower shelf position.

For toasting, and for grilling foods such as bacon, sausages or steaks, use a higher shelf position.

For thicker foods such as chops or chicken joint pieces, use a middle to low shelf position.

The grill trivet, inside the grill pan, can be inverted to give a high or low position, or it may be removed.

The HIGH trivet position is suitable for toasting bread.

The LOW trivet position is suitable for grilling all types of meat & fish.

With the grill trivet removed the food is placed directly on the base of the grill pan - eg; when cooking whole fish or browning dishes such as cauliflower cheese.

When you have finished grilling, check that the control knob is returned to the off position.

Cleaning

Caution: Any cleaning agent used incorrectly may damage the appliance.

Always let the cooker cool before cleaning.

Some cooking operations generate considerable amount of grease, this combined with spillage can become a hazard if allowed to accumulate on the cooker through lack of cleaning. In extreme cases this may amount to misuse of the appliance and could invalidate your guarantee.

Do not use caustic, corrosive or abrasive cleaning products, products containing bleach, coarse wire wool or any hard implements, as they will damage the surfaces.

All parts of the appliance can be safely cleaned with a cloth wrung out in hot soapy water.

Painted, plastic and metal finish parts (if fitted)

METAL DOOR PANEL (if fitted), OVEN DOOR FRAME & HANDLE, GRILL PAN HANDLE, FACIA PANEL & CONTROL KNOBS

Only use a clean cloth wrung out in hot soapy water.

Burner caps and heads

Important: Allow burners to cool before cleaning.

Caution: Hotplate burners can be damaged by soaking, automatic dishwashers (or dishwasher powders / liquids), caustic pastes, hard implements, coarse wire wool, and abrasive cleaning pastes.

Clean with a moist soapy pad - eg; "Brillo".

For the burners to work safely, the slots in the burner head where the flames burn need to be kept clear of deposit. Clean with a nylon brush, rinse, and dry thoroughly.

Important: The burner caps and heads must be repositioned correctly so that they sit squarely onto the hob as shown.

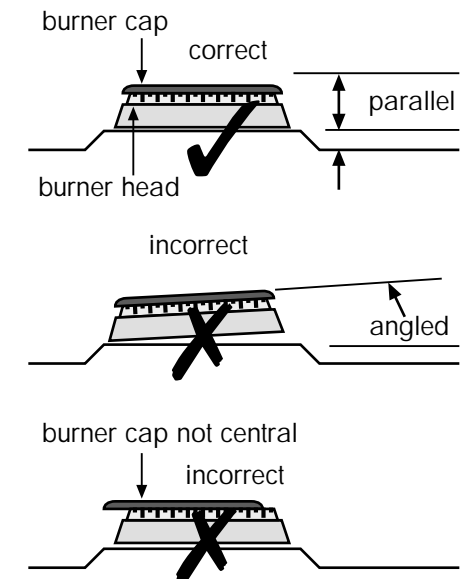

Minute Minder (if fitted)

Initial display

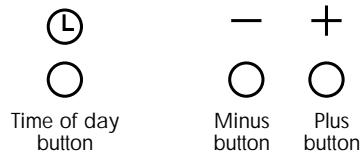
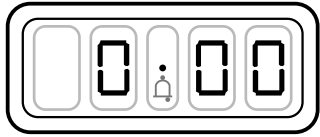

The digital timer enables you to set the time of day (24 hour clock) and the minute minder alarm.

Setting the "Time of Day"

1. Switch on the electricity supply to the appliance.
The display will flash.
2. Press and release the *time of day* button.
3. Set the time of day with the *plus* and *minus* buttons.
4. The time will be set 7 seconds after the last plus or minus operation.

Alarm tones

After setting the time of day, you can select one of three alarm tones.

Press the *minus* button to listen to the first tone, then release the *minus* button and press it again to listen to the second tone, etc.

Releasing the *minus* button after a tone has sounded will automatically select that tone.

Setting the minute minder

1. Press and release the *plus* button to change the display from clock to minute minder - the bell symbol will light.
2. Use the *plus* and *minus* buttons to set the length of time before the alarm tone will sound. The display will increase / decrease in units of 10 seconds up to 99 minutes 50 seconds, and in units of 1 minute from 1 hour 40 minutes upwards. The maximum period which may be set is 10 hours.

The display format will change after 99 minutes and 50 seconds to 1 hour and 40 minutes.

During countdown, the minute minder has priority on the display, which will show (in *minutes : seconds*, or *hours : minutes*) the time remaining.

When countdown is complete, the tone will sound for 7 minutes, or it can be reset with one touch of any button.

To cancel the minute minder at any other time, run down the set time with the *minus* button.

The display will revert to show the time of day.

Using the Top Oven

Accessible parts may be hot when the oven is used. Young children should be kept away.

To turn on the top oven

Turn the top oven / grill control knob to the required temperature setting.

The red thermostat indicator (if fitted) will come on until the selected temperature is reached and then go off; it will turn on and off periodically as the thermostat operates to maintain the selected temperature.

To switch off, return the control knob to the "off" position.

Preheating

The oven must be preheated when cooking frozen or chilled foods, and we recommend preheating for yeast mixtures, batters, soufflés and whisked sponges. Preheat the oven until the indicator light switches off for the first time - this will take up to 20 minutes depending on the temperature selected. If you are not preheating the oven, the cooking times in the baking guide may need to be extended, as they are based on a preheated oven.

Notes:

As part of the cooking process, hot air is expelled through a vent at the top of the oven(s). When opening the oven door, care should be taken to avoid any possible contact with potentially hot air, since this may cause discomfort to people with sensitive skin. We recommend that you hold the underneath of the oven door handle.

Important: Never put items directly on the base of the oven with foil, as this may cause the element to overheat. Always position items on the shelf.

Caution: The top element gets extremely hot when in use, so take extra care to avoid touching it.

The cooling fan

When the top oven is switched on, you will hear the cooling fan come on - this keeps the fascia and control knobs of the appliance cool during cooking only. The fan will continue to operate for a period after the oven control has been switched off.

Should any fault occur with the cooling fan, the appliance will require servicing - contact Customer Care.

Using the Top Oven

Top oven baking guide

Cooking times

These times are based on cooking in a preheated oven.

These cooking times are approximate, because the size and type of cooking dish will influence time as personal preferences.

Shelf positions

As a general guide, when cooking frozen or chilled food, use the highest possible shelf position, while allowing some clearance between the food and the top element. Follow the instructions given on packaging.

Cooking temperatures

The temperature settings and time given in the Baking Guides are based on dishes made with block margarine. If soft tub margarine is used, it may be necessary to reduce the temperature setting. If a recipe gives a different temperature setting to that shown in the guide, the recipe instruction should be followed.

Because the top oven is more compact, it may be necessary to reduce cooking temperatures specified in recipes by up to 20°C.

Use the baking guide as a reference for determining which temperatures to use.

Item	Temperature °C	Shelf position	Approximate cooking time
Small cakes	180	middle	15 - 20 mins
Victoria sandwich (2 x 180mm / 7")	160	middle	20 - 25 mins
Swiss roll	200	middle	8 - 12 mins
Semi rich fruit cake (180mm x 7")	140	low	2¼ - 2¾ hours
Scones	215	top	10 - 15 mins
Meringues	90 - 100	low	2 - 3 hours
Shortcrust pastry	200 - 210	middle	Depends on size & type of cooking dish & also the filling
Puff / flaky pastry	200 - 210	middle	
Choux pastry	200 - 210	middle	
Biscuits	160 - 200	top	10 - 20 mins
Sponge pudding	150	middle	30 - 45 mins
Milk pudding	140	low	2 - 2½ hours

Using the Ovens

Roasting guide

The times given in the roasting guide are only approximate, because the size and age of the bird will influence cooking times as will the shape of a joint and the proportion of the bone.

Frozen meat should be thoroughly thawed before cooking. For large joints it is advisable to thaw overnight.

Frozen poultry should be thoroughly thawed before cooking. The time required depends on the size of the bird - eg; a large turkey may take up to 48 hours to thaw.

Use of a trivet with a roasting tin will reduce fat splashing and will help to keep the oven interior clean. Alternatively, to help reduce fat splashing, potatoes or other vegetables can be roasted around the meat / poultry.

Notes:

- When cooking stuffed meat or poultry calculate the cooking time from the total weight of the meat plus the stuffing.
- For joints cooked in foil or covered roasters, and for lidded casseroles, add 5 minutes per 450g (1lb) to the calculated cooking time.
- Smaller joints weighing less than 1.25kg (2½lb) may require 5 minutes per 450g (1lb) extra cooking time.
- Position the oven shelf so that the meat or poultry will be in the centre of the oven.
- It is recommended that the appliance is cleaned after open roasting.

Cook in oven at: 180°C - Main Oven (Fanned) 200°C - Top Oven (Conventional)		Approximate Cooking Time (preheated oven)
Beef	Rare	20 minutes per 450g (1lb), plus 20 minutes
	Medium	25 minutes per 450g (1lb), plus 20 minutes
	Well done	30 minutes per 450g (1lb), plus 30 minutes
Lamb	Medium	25 minutes per 450g (1lb), plus 25 minutes
	Well done	30 minutes per 450g (1lb), plus 30 minutes
Pork		35 minutes per 450g (1lb), plus 35 minutes
Poultry		20 minutes per 450g (1lb), plus 20 minutes

Using the Ovens

Traditional fruit cakes

It should be remembered that ovens can vary over time, therefore cooking times can vary, making it difficult to be precise when baking fruit cakes.

It is necessary therefore, to test the cake before removal from the oven. Use a fine warmed skewer inserted into the centre of the cake. If the skewer comes out clean, then the cake is cooked.

- Do not attempt to make Christmas cakes larger than the oven can cope with, you should allow at least 25mm (1 inch) space between the oven walls and the tin.
- Always follow the temperatures recommended in the [recipe](#).
- To protect a very rich fruit cake during cooking, tie 2 layers of brown paper around the tin.
- We recommend that the cake tin is not stood on layers of brown paper, as this can hinder effective circulation of air.
- Do not use soft tub margarine for rich fruit cakes, unless specified in the recipe.
- Always use the correct size and shape of tin for the recipe quantities.

Roast turkey

Roasting turkey involves cooking two different types of meat - the delicate light breast meat, which must not be allowed to dry out, and the darker leg meat, which takes longer to cook.

The turkey must be roasted long enough for the legs to cook, so frequent basting is necessary. The breast meat can be covered once browned.

- Always make sure that the turkey is completely thawed and that the giblets are removed before cooking.
- Turkey should be roasted at 180°C for 20 minutes per 1lb, plus 20 minutes, unless packaging advises otherwise.
- The turkey can be open roasted, breast side down, for half of the cook time, and then turned over for the remainder of the cooking time.
- If the turkey is stuffed, add 5 minutes per 1lb to cook time.
- If roasting turkey covered with foil, add 5 minutes per 1lb to cook time.

To test if the turkey is cooked, push a fine skewer into the thickest part of the thigh. If the juices run clear, the turkey is cooked. If the juices are still pink, the turkey will need longer cooking.

Using the Main Oven

Accessible parts may be hot when the oven is used. Young children should be kept away.

To switch on the oven

Turn the oven control knob clockwise to the required setting.

The red thermostat indicator (if fitted) will come on until the selected temperature is reached and then go off; it will turn on and off periodically as the thermostat operates to maintain the selected temperature.

To switch off, return the control knob to the "off" position.

Preheating

The oven **must** be preheated when cooking frozen or chilled foods, and we recommend preheating for yeast mixtures, batters, soufflés and whisked sponges. Preheat the oven until the indicator light (if fitted) switches off for the first time, this will take up to 20 minutes, depending on the temperature selected.

If you are not preheating the oven, the cooking times in the following guide may need to be extended, as they are based on a preheated oven.

Oven shelves

The oven shelf must be positioned with the upstand at the rear of the oven and facing upwards.

Position baking trays and roasting tins on the middle of the shelves, and leave one clear shelf position between shelves, to allow for circulation of heat.

Baking tray and roasting tins

For best cooked results and even browning, the maximum size baking trays and roasting tins that should be used are as follows;

500mm models:

Baking tray 290mm x 270mm

Roasting tin 320mm x 270mm

550 / 600mm wide models:

Baking tray 350mm x 280mm

Roasting tin 370mm x 320mm

We recommend that you use good quality cookware. Poor quality trays and tins may warp when heated, leading to uneven baking results.

Notes:

As part of the cooking process, hot air is expelled through a vent at the top of the oven(s). When opening the oven door, care should be taken to avoid any possible contact with potentially hot air, since this may cause discomfort to people with sensitive skin. We recommend that you hold the underneath of the oven door handle.

Using the Main Oven

Cooking with a fanned oven

If you are used to cooking with a conventional oven you will find a number of differences to cooking with a fan oven which will require a different approach:

There are no zones of heat in a fan oven as the convection fan at the back of the oven ensures an *even temperature* throughout the oven. This makes it ideal for batch baking - eg; when planning a party or stocking the freezer - as all the items will be cooked within the same length of time.

Foods are cooked at a *lower temperature* (between 10°C and 20°C lower) than a conventional oven, so conventional recipe temperature may have to be reduced.

Preheating is generally not necessary as a fan oven warms up quickly.

There is no flavour transference in a fan oven, which means you can cook strong smelling foods such as fish at the same time as mild foods - eg; milk puddings.

When batch baking foods that will rise during cooking - eg; bread - always ensure that enough space has been left between the shelves to allow for the rise.

Notes:

When 2 or more shelves are being used, it may be necessary to increase the cooking time slightly.

Because the 2 oven shelves are wider than in many ovens, it is possible to cook 2 items per shelf - eg; 2 victoria sandwiches or 2 casseroles.

Although you need to keep in mind the points '*To help the air circulate freely*' with careful choice of dishes and tins, it is possible to cook a complete meal, and perhaps something else for the freezer, in the oven at the same time.

When roasting meats, you will notice that fat splashing is reduced, which is due in part to the lower oven temperatures, and will help keep cleaning of the oven to a minimum.

Because a fan oven has an even temperature throughout the oven, food will cook in the same way on any shelf position. There is no need to interchange dishes onto different shelves part way through cooking, as with a conventional oven.

To help the air circulate freely

Position the shelves evenly within the oven and maintain a clearance from the oven roof and base.

If more than one cooking dish or baking tray is to be used on a shelf, leave a gap of at least 25mm between the items themselves and the oven interior.

Allow enough space between shelves for food that will rise during cooking.

Do not place items on the oven base as this will prevent air circulating freely.

Using the Main Oven

Item	Temperature at °C	
	Fanned	Approximate cooking time (preheated oven)
Small cakes	175	15 - 25 mins
Whisked sponge	170	20 - 25 mins
Swiss Roll	190	10 - 12 mins
Victoria Sandwich (2 x 205mm / 8in)	160	20 - 30 mins
Semi rich fruit cake (180mm / 7in)	125	2½ - 3 hours
Scones	210	10 - 15 mins
Meringues	90 - 100	2½ - 3 hours
Shortcrust pastry	190	depends on size & type of dish & type of filling
Puff / Flaky pastry	190	
Choux pastry	190	
Biscuits	160 - 200	20 - 30 mins
Sponge pudding	150	45 mins - 1 hour
Milk pudding	150	1½ - 1¾ hours

Cooking times & temperatures

The temperature settings and times given in the baking guide are based on dishes made with block margarine. If soft tub margarine is used it may be necessary to reduce the temperature setting.

If a recipe gives a different temperature setting to that shown in the guide, the recipe instruction should be followed.

The times given in the baking guide are based on cooking in a preheated oven.

Aluminium foil

Use foil only to cover food or cooking dishes, using foil to cover the shelves or oven base creates a fire hazard.

Slow cooking

- Make sure that frozen foods are thoroughly THAWED before cooking.
- Do not slow cook joints of meat or poultry weighing more than 2¼kg / 4½lb.
- For roasting joints of meat or poultry, and for pot roasts preheat the oven to 190°C and cook for 30 minutes, then adjust the oven control to the 110°C - 120°C (slow setting) for the remainder of the cooking time.
- Slow cooking times will be about 3 times as long as conventional cooking times.