



user manual

Oven
EQU43002

We were thinking of you
when we made this product

GB

Welcome to the world of Electrolux

You've chosen a first class product from Electrolux, which hopefully will provide you with lots of pleasure in the future. Electrolux ambition is to offer a wide variety of quality products that would make your life even more comfortable. You can look at some examples on the cover in this manual. But now it's time to study this manual and start using and enjoying the benefits from your new machine. We promise that it'll make your life a little easier. Good luck!

Contents

Important safety information	5
Product description	7
Before using the appliance	8
Operation	10
Programme charts	17
Hints and tips	21
What to do if...	23
Care and cleaning	25
Technical data	29
Installation	30
Environment	35
Guarantee / Customer care	36
European guarantee	38

The following symbols are used in this user manual:



Important information concerning your personal safety and information on how to avoid damaging the appliance.



General information and tips



Environmental information



Important safety information

These warnings are provided in the interests of your safety. Ensure that you understand them all before installing or using the appliance.

Your safety is of paramount importance. If you are unsure about any of the meanings of these warnings please contact customer care.

Installation

The appliance must be installed according to the instructions supplied.

The installation work must be undertaken by a qualified electrician or competent person.

The appliance should be serviced by an authorised Service Engineer and only genuine approved spare parts should be used.

The appliance must be installed in an adequately ventilated room.

It is imperative that the appliance is left in the base to protect both the appliance and the floor.

This appliance is heavy and care must be taken when moving it.

Do not attempt to lift or move this appliance by the handles.

All packaging, both inside and outside the appliance must be removed before the appliance is used.

It is dangerous to alter the specifications or modify the appliance in any way.

Child safety

Do not allow children to play with any part of the packaging.

Do not allow children to sit or climb on the drop down doors.

This appliance is not intended for use by children and other persons whose physical, sensory or mental capabilities or lack of experience and knowledge prevents them from using the appliance safely without supervision or instruction by a responsible person to ensure that they can use the appliance safely.

Children should be supervised to ensure that they do not play with the appliance.



CAUTION: Accessible parts may be hot. Young children should be kept away.

During use

This appliance is not intended to be operated by means of an external timer or separate remote control system.

This appliance has been designed for domestic use to cook edible foodstuffs only and must not be used for any other purposes.

Take great care when heating fats and oils as they will ignite if they become too hot.

6 **electrolux** important safety information

Never place plastic or any other material that may melt in or on the oven.

Do not leave the grill pan handle in position when grilling as it will become hot.

Always use oven gloves to remove and replace the grill pan handle when grilling.

Always support the grill pan when it is in the withdrawn or partially withdrawn position.

Always use oven gloves to remove and place food in the oven.

During use the appliance becomes hot. Care should be taken to avoid touching the heating elements inside the oven.

Ensure that all vents are not obstructed to ensure ventilation of the oven cavity.

Never line any part of the appliance with foil.

Always stand back from the appliance when opening the oven door to allow any build up of steam or heat to release.

Stand clear when opening the drop down doors. Support the doors using the handles until fully open.



Never leave the appliance unattended when the oven door is open.

Do not place sealed cans or aerosols inside the oven. They may explode if they are heated.

Ensure that all control knobs are in the OFF position when not in use.

Do not stand on the appliance or on the open oven doors.

Do not hang towels, dishcloths or clothes from the appliance or its handles.

Do not use this appliance if it is in contact with water. Never operate it with wet hands.

Cleaning and maintenance



For hygiene and safety reasons this appliance should be kept clean at all times. A build-up of fat or other foodstuff could result in a fire especially in the grill pan.

Do not leave cookware containing foodstuffs, e.g. fat or oil in the appliance in case it is inadvertently switched on.

Always allow the appliance to cool before switching off at the wall prior to carrying out any cleaning/maintenance work.

Only clean this appliance in accordance with the instructions given in this book.

Never use steam or high pressure steam cleaners to clean the appliance.

Product description

- 1** Control Panel
- 2** Top Oven/Grill
- 3** Main Oven

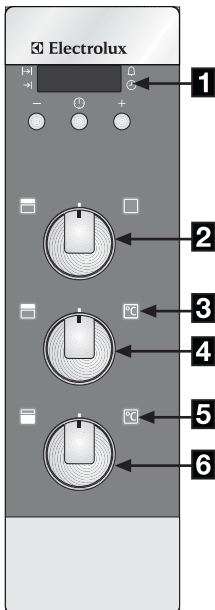
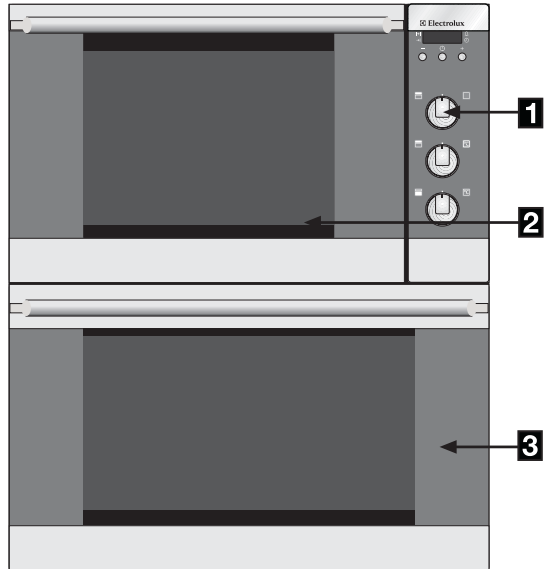

- 1** Electronic timer
- 2** Top Oven/ Grill Function Selector
- 3** Top Oven/ Grill Temperature Indicator Neon
- 4** Top Oven/Grill Temperature Control
- 5** Main Oven Temperature Indicator Neon
- 6** Main Oven Temperature Control

Before using the appliance

Rating plate

This is situated on the front frame of the appliance and can be seen upon opening the door. Alternatively the rating plate may also be found on the back or top of some models (where applicable).

The appliance must be protected by a suitably rated fuse or circuit breaker.

The rating of the appliance is given on the rating plate.

Do not remove the rating plate from the appliance as this may invalidate the guarantee.

Preparing to use your appliance

Wipe over the base of the oven(s) with a soft cloth using hot soapy water.

Wash the furniture before use.

We suggest that you run the oven(s) and grill for 10 – 15 minutes at maximum temperature, to burn off any residue from their surfaces. Accessible parts may become hotter than in normal use. Children should be kept away. During this period an odour may be emitted, it is therefore advisable to open a window for ventilation.

The cooling fan for the controls

The cooling fan comes on immediately when the grill is switched on and after a short time when the oven is in use. It may run on after the controls are switched off until the appliance has cooled.

During the initial period the cooling fan may turn on and off, this is quite normal.



Always allow the cooling fan to cool the appliance down before switching off at the wall prior to carrying out any cleaning or maintenance work.

Control panel indicator neon(s)

The indicator neon will operate when the grill (where applicable) or oven(s) is switched on. The indicator neon will glow. It may turn on and off during use to show that the setting is being maintained. If the neon does not operate as the instructions indicate the controls have been incorrectly set. Return all controls to zero and reset following the instructions for the required setting.

Condensation and steam

When food is heated it produces steam similar to a boiling kettle. The vents allow some of this steam to escape. However, always stand back from the appliance when opening the door(s) to allow any build up of steam or heat to release.

If the steam comes into contact with a cool surface on the outside of the appliance, e.g. a trim, it will condense and produce water droplets. This is quite normal and is not caused by a fault on the appliance.

To prevent discolouration, regularly wipe away condensation and foodstuff from surfaces.

For your safety wall coverings at the rear of the appliance should be securely fixed to the wall.

Cookware

Baking trays, dishes etc., should not be placed directly against the grid covering the fan at the back of the oven.

Do not use baking trays larger than 30cm x 35cm (12" x 14") as they will restrict the circulation of heat and may affect performance.

Grill and oven furniture

The following items of grill and oven furniture have been supplied with the appliance. If you require replacements of any of the items listed below please contact your local service force centre.

1 grill pan grid

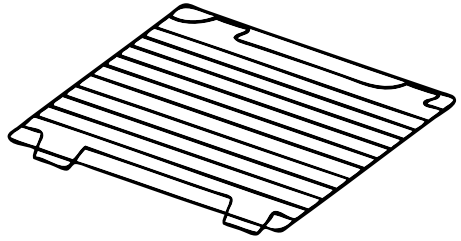

1 straight shelf
(For grilling and top oven cooking)

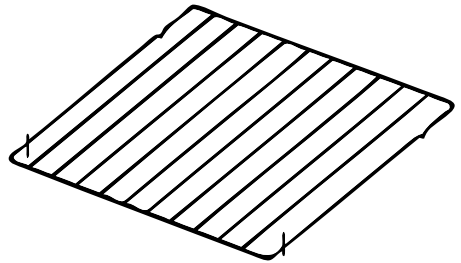

1 grill pan

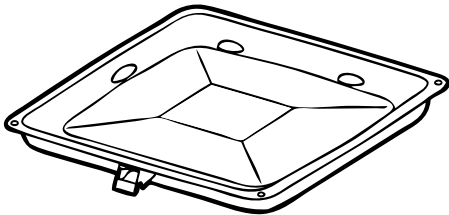

1 grill pan handle

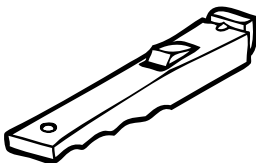

2 straight shelves
(For main oven cooking)

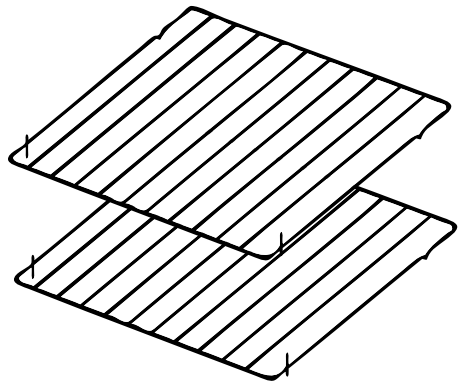

The timer



Key

1. Cook time indicator neon
2. End time indicator neon
3. Countdown indicator neon
4. Time indicator neon
5. Decrease control
6. Selector control
7. Increase control



The time of day must be set before the main oven will operate manually.

To set the time of day

The oven has a 24 hour clock. When the electricity supply is first switched on, the display will show 12:00 and the 'Time' indicator neon  will flash.

To set the correct time press the increase control button **+** and if necessary, the decrease control button **-** until the correct time on the 24 hour clock is reached. The 'Time' indicator neon  will flash for 5 seconds and then go out.





The increase and decrease control buttons operate slowly at first, and then more rapidly. They should be pressed separately.

To set the countdown

The 'Countdown' gives an audible reminder at the end of any period of cooking.

This cooking period may be up to 2 hrs 30 mins. It is not part of the automatic control.

To set, press the Selector Control button  until the 'Countdown' indicator neon  is illuminated and the display reads 0:00.





To set the required time duration, press the increase control **+** until the display indicates the interval to be timed. If necessary press the decrease control **-** to achieve the correct time interval.



This must be completed within 5 seconds of first pressing the Selector Control button.

During the operation of the 'Countdown', the remaining time period will be shown in the display. The 'Countdown' will sound intermittently for up to 2 minutes at the end of the timed period. The sound can be stopped by pressing any button.

To cancel the countdown





If you change your mind and want to cancel the 'Countdown', press the Selector Control button  until the 'Countdown' indicator neon  flashes then depress the decrease control  until 0:00 shows in the display. The 'Countdown' indicator neon  will continue to flash for a few seconds and then return to the time of day.

To set the oven timer control

Only the main oven can be automatically timed.

When using the timer control for the very first time, it is advisable to let it operate while you are at home. The display can be checked to show that it is operating correctly and you will feel confident to leave a meal to cook automatically in the future.







To set the timer to switch on and off automatically

1. Ensure the electricity supply is switched on and that the correct time of day is displayed.
2. Place food in oven.
3. To set the length of cooking time. Press the Selector Control button  until the 'Cook Time' indicator neon  is illuminated.
4. Press the increase control  until the required length of cooking time is displayed. If necessary press the decrease control  until the correct time interval is achieved. The maximum cooking time is 10 hours.

5. Release the buttons. The 'Cook Time' indicator neon  will be illuminated.



Remember, this must be completed within 5 seconds of first pressing the Selector Control button.







6. To set the 'End Time'. Press the Selector Control button  until the 'End Time' indicator neon  flashes. Press the increase control button  until the required stop time is displayed. If necessary press the decrease control  until the required time interval is achieved.
7. Release the buttons. The time of day will be displayed after 5 seconds. The 'Cook Time'  and 'End Time'  indicator neons will be illuminated.
8. Set the main oven control to the required temperature. The oven indicator neon should be off.







When the automatic timed period starts, the oven indicator neon will turn on and off periodically during cooking, showing that the temperature is being maintained.

12 electrolux operation

To set the timer to switch off only

1. Ensure the electricity supply is switched on and that the correct time of day is displayed.
2. Place food in the oven.
3. To set the length of cooking time, press the Selector Control button  until the 'Cook Time' indicator neon  is illuminated. Press the increase control  until the required length of cooking time is displayed. Press the decrease control  if necessary.
4. Release the buttons. The 'Cook Time' indicator neon  will illuminate and the time of day will be displayed after 5 seconds.
5. Set the oven temperature. The oven indicator neon should be on.
6. To check the 'End Time' during the cooking period, simply press the Selector Control button  once and the remaining time will be displayed.

To cancel an automatic programme

1. To cancel an automatic programme press the Selector Control button  until the 'Cook Time' indicator neon  flashes. Press the decrease control  until the display reads 0:00.
2. Release the buttons. The 'Cook Time' indicator neon  will flash and after 5 seconds return to the time of day.
3. Turn off the oven controls.

To return the appliance to manual

At the end of a timed cooking period, the 'End Time' indicator neon  will flash and an alarm will sound for up to 2 minutes.

1. To stop the sound, press any of the three buttons.
2. The display will return to the time of day.
3. Turn off the oven controls.

Things to note

In the event of an interruption of the electricity supply, the timer will reset it self and all programming will be cancelled.

Your timer has an energy save mode which allows you to switch the display off. For setting details please refer to the environmental chapter of this manual.

Automatic cooking

It is advisable to leave food in the oven for as short a time as possible before automatic cooking. Always ensure commercially prepared food is well within its use by date and that home prepared food is fresh and of good quality.

When cooking is complete, do not leave food to stand in the oven, but remove and cool it quickly if the food is not to be consumed immediately.

Always ensure food in the oven has been covered before cooking if it is not possible to remove food immediately after cooking.

The grill





CAUTION: Accessible parts may be hot when the grill is in use. Young children should be kept away.



The grill is a dual circuit grill which means that the full area of the grill can be used, or for economy purposes, the centre section only can be used when cooking smaller quantities of food.

Using the dual grill

- Turn the top oven/grill function selector  to the required power setting.

The grill settings are as follows: -

	Centre grill area at full power.
	Full grill area at full power.

- Turn the top oven/grill temperature control to the right as far as it will go. This is the hottest setting .
- To use the grill at a lower setting turn the top oven/grill temperature control knob to a lower setting .

Things to note

- To oven light will illuminate.
- The indicator neon will glow. It may turn on and off during use to show that the setting is being maintained.
- The cooling fan for the controls may operate after a time.
- Some smoke from fat splashes may be evident as the grill cleans itself.
- Never cover the grill pan or grid with foil as this can lead to grill fires.

To fit the grill pan handle

To insert the handle, press the button on the handle with the thumb and pivot the handle slightly upwards inserting the lip into the widest part of the bracket.

Move the handle towards the left, lower into position and release the button.

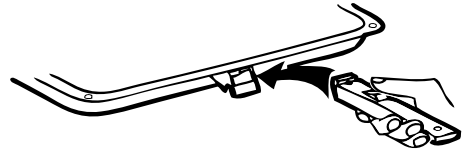

Ensure the handle is correctly located when lifting the grill pan.

To remove the handle, press the button on the handle with the thumb and pivot the handle slightly upwards and towards the right to remove from the bracket.



Always remove the grill pan handle during grilling.

Protect your hands when removing the grill pan handle.

To correctly locate the grill pan on the shelf, ensure that the cut out on the underside of the handle bracket locates over the front bar of the shelf.

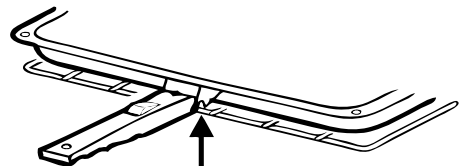



The top oven

The top oven is the smaller of the two ovens. It is heated by elements in the top and bottom of the oven. It is designed for cooking smaller quantities of food. It gives especially good results if used to cook fruitcakes, sweets and savoury flans or quiche.

The top oven is ideal for use as a warming compartment. It can be used to warm dishes and keep food hot. Use the lowest setting on the top oven temperature control.

Using the top oven

- Turn the top oven/grill function selector to the required setting .
- Turn the top oven/grill temperature control to the required setting .

Things to note

- The oven light will illuminate.
- The indicator neon will glow. It may turn on and off during use to show that the setting is being maintained.
- The cooling fan for the controls may operate after a time.



Do not place dishes, tins and trays directly on the oven base as it becomes very hot and damage will occur.

To fit the top oven shelf

The shelf should be fitted with the straight rods uppermost on the frame and the forms towards the back of the oven.

To remove a shelf slide the shelf towards you until the shelf stop is reached. Tilt shelf up at the front so that the stops clear the side supports. Lift shelf clear.

To install a shelf, reverse the above steps. Each shelf position has an upper and lower support wire, ensure the shelf is placed between these two support wires.



Do not place cookware and cooking pots with rough bases e.g. cast iron on the oven door as damage to the glass may occur.

The fan oven

The fan oven is particularly suitable for cooking larger quantities of food.

The advantages of fan oven cooking are:

Preheating

The fan oven quickly reaches its temperature, so it is not usually necessary to preheat the oven. Without preheating however, you may need to add an extra 5 – 10 minutes on the recommended cooking times. For recipes needing high temperatures, e.g. bread, pastries, scones, soufflés etc., best results are achieved if the oven is preheated first. For best results when cooking frozen or cooked chilled ready meals always preheat the oven first.

Cooking temperatures

Fan oven cooking generally requires lower temperatures than conventional cooking. Follow the temperatures recommended in the cooking chart. As a guide reduce temperatures by about 20°C – 25°C for your own recipes, using a conventional oven.

Batch baking

The fan oven cooks evenly on all shelf levels, especially useful when batch baking.

Using the fan oven

- Turn the main oven temperature control to the required setting $\square^{\circ\text{C}}$.

Things to note

- The oven light will illuminate.
- The indicator neon will glow. It may turn on and off during use to show that the setting is being maintained.
- The cooling fan for the controls may operate after a time.



Do not place cookware and cooking pots with rough bases e.g. cast iron on the oven door as damage to the glass may occur.

To fit the main oven shelves

The shelves should be fitted with the straight rods uppermost on the frame and the forms towards the back of the oven.

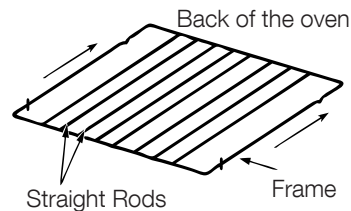

To remove a shelf slide the shelf towards you until the shelf stop is reached. Tilt shelf up at the front so that the stops clear the side supports. Lift shelf clear.

To install a shelf, reverse the above steps. Each shelf position has an upper and lower support wire, ensure the shelf is placed between these two support wires.

Defrost

This function defrosts most foods faster than more conventional methods. It is particularly suitable for delicate frozen foods, which are to be served cold e.g. cream filled gateaux, cakes covered with icings or frostings, cheesecakes, biscuits, scones, etc.

Using the defrost feature

- Turn the main oven temperature control to the required setting. ❄️

Things to note

- The oven fan and interior light will come on.

Grilling chart

FOOD	GRILL TIME (mins in total)
Bacon Rashers	5 - 6
Beef Burgers	10 - 15
Chicken Joints	30 - 40
Lamb Chops	15 - 20
Pork Chops	20 - 30
Whole Trout/Mackerel	15 - 25
Plaice/Cod Fillets	10 - 15
Kebabs	20 - 30
Kidneys – Lamb/Pig	8 - 12
Liver – Lamb/Pig	10 - 20
Sausages	20 - 30
Steak – Rare	6 - 12
Steak – Medium	12 - 16
Steak – Well Done	14 - 20
Toasted Sandwiches	3 - 4

The times quoted above are given as a guide and should be adjusted to suit personal taste.

Adjust the grill setting and the grill pan grid to suite different thicknesses of food.

Oven cooking chart

The oven temperatures are intended as a guide only. It may be necessary to increase or decrease the temperatures to suit individual preferences and requirements.

FOOD	FAN OVEN	TOP OVEN		APPROX COOK TIME (m)
	COOKING TEMP °C	POS	COOKING TEMP °C	
Biscuits	180 - 190	3	170 - 190	10 - 20
Bread	200 - 220	3	200 - 220	25 - 30
Bread rolls/buns	200 - 220	3	200 - 220	15 - 20
Small / Queen Cakes	160 - 170	3	180 - 190	18 - 25
Sponges	160 - 170	2	160 - 170	18 - 20
Victoria Sandwich	160 - 170	2	160 - 170	18 - 25
Madeira Cake	140 - 150	3	140 - 150	1¼ - 1½h
Rich Fruit Cake	130 - 140	3	140 - 150	2¼ - 2½h
Christmas Cake	130 - 140	2	130 - 140	3 - 4½h
Gingerbread	140 - 150	3	140 - 150	1¼ - 1½h
Meringues	80 - 100	2	90 - 100	2½ - 3h
Flapjack	170 - 180	3	170 - 180	25 - 30
Shortbread	130 - 140	3	140 - 150	45 - 65
Fruit Pies, Crumbles	190 - 200	3	190 - 200	40 - 50
Milk Puddings	130 - 140	3	140 - 150	1½ - 2h
Scones	210 - 220	3	220 - 230	8 - 12

Oven cooking chart continued

FOOD	FAN OVEN	TOP OVEN		APPROX COOK TIME (m)
	COOKING TEMP °C	POS	COOKING TEMP °C	
Choux Pastry	190 - 200	3	180 - 190	30 - 35
Éclairs / Profiteroles	170 - 180	3	170 - 180	20 - 30
Flaky Pastry	210 - 220	3	210 - 220	25 - 40
Mince Pies	190 - 200	3	190 - 200	15 - 20
Pasta Lasagne etc.	190 - 200	3	170 - 180	40 - 45
Meat Pies	190 - 210	3	190 - 210	25 - 35
Quiche, Tarts, Flans	180 - 210	3	180 - 200	25 - 45
Shepherd's Pie	190 - 200	3	190 - 200	30 - 40
Soufflés	170 - 180	3	170 - 180	20 - 30
Fish	170 - 190	3	170 - 190	20 - 30
Fish Pie	190 - 200	3	190 - 200	20 - 25
Beef Casserole	140 - 160	2	140 - 160	2½ - 3h
Lamb Casserole	140 - 160	2	140 - 160	2½ - 3h
Convenience Foods	Follow manufacturer's instructions			
Baked Potatoes	180 - 190	3	180 - 190	1 - 1½h
Roast Potatoes	180 - 190	3	180 - 190	1 - 1½h
Large Yorkshire Puddings:	210 - 220	3	200 - 210	25 - 40
Individual Yorkshire Puddings	200 - 210	3	200 - 210	15 - 25

Note: Shelf positions are counted from the bottom of the oven.

Note: Fan oven shelf positions are not critical but ensure that they are evenly spaced when more than one is used.

Roasting chart

MEAT	TEMPERATURE	COOKING TIME
Beef/ Beef boned	160-180°C	20-35 minutes per ½kg (1lb) and 20-35 minutes over
Mutton/Lamb	160-180°C	25-35 minutes per ½kg (1lb) and 25-35 minutes over
Pork/Veal/Ham	160-180°C	30-40 minutes per ½kg (1lb) and 30-40 minutes over
Chicken	160-180°C	15-20 minutes per ½kg (1lb) and 20 minutes over
Turkey/Goose	160-180°C	15-20 minutes per ½kg (1lb) up to 3½kg (7lb) then 10 minutes per ½kg (1lb) over 3½kg (7lb)
Duck	160-180°C	25-35 minutes per ½kg (1lb) and 25-30 minutes over
Pheasant	160-180°C	35-40 minutes per ½kg (1lb) and 35-40 minutes over
Rabbit	160-180°C	20 minutes per ½kg (1lb) and 20 minutes over

INTERNAL TEMPERATURES –

Rare: 50-60°C; Medium: 60-70°C; Well done: 70-80°C

The roasting temperatures and times given in the chart should be adequate for most joints, but slight adjustments may be required to allow for personal requirements and the shape and texture of the meat. However, lower temperatures and longer cooking times are recommended for less tender cuts or larger joints.

Wrap joints in foil if preferred, for extra browning uncover for the last 20 – 30 min. cooking time.

Hints and tips

Hints and tips when using the grill

- Most foods should be placed on the grid in the grill pan to allow maximum circulation of air and to lift the food out of the fats and juices.
- Adjust the grid and grill pan runner position to allow for different thicknesses of food.
- Position the food close to the element for faster cooking and further away for gentler cooking.
- Food should be thoroughly dried before grilling to minimise splashing. Brush lean meats and fish lightly with a little oil or melted butter to keep them moist during cooking.
- Accompaniments such as tomatoes and mushrooms may be placed underneath the grid when grilling meats.
- When toasting bread, use the shelf in the top position with the grid in the 'high' position.
- Preheat the grill on a full setting for a few minutes before sealing steaks or toasting. Adjust the heat setting and the shelf as necessary during cooking.
- The food should be turned over during cooking as required.
- When using the centre section grill, ensure food is placed centrally on the grilling grid directly beneath the grill element.

Hints and tips when using the top oven

- Arrange the shelves in the required positions before switching the oven ON. Shelf positions are counted from the bottom upwards.
- There should always be at least 2.5cm (1") between the top of the food and the element. This gives best cooking results and allows room for rise in yeast mixtures, Yorkshire puddings etc. When cooking cakes, pastry, scones bread etc., place the tins or baking trays centrally on the shelf.
- Ensure that food is placed centrally on the shelf and there is sufficient room around the baking tray/dish to allow for maximum circulation.
- Stand dishes on a suitably sized baking tray on the shelf to prevent spillage onto the oven base and to help reduce cleaning.
- The material and finish of the baking tray and dishes used affect base browning. Enamelware, dark, heavy or non-stick utensils increase base browning. Shiny aluminium or polished steel trays reflect the heat away and give less base browning.
- Because of the smaller cooking space and lower temperatures, shorter cooking times are sometimes required. Be guided by the recommendations given in the cooking chart.

22 **electrolux** hints and tips

- For economy leave the door open for the shortest possible time, particularly when placing food into a pre-heated oven.

Hints and tips when using fan cooking

- Arrange the shelves in the required positions before switching the oven on. Shelf positions are counted from the bottom upwards.

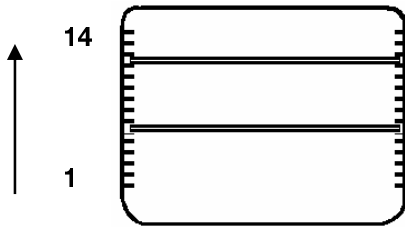

- When cooking more than one dish in the fan oven, place dishes centrally on different shelves rather than cluster several dishes on one shelf, this will allow the heat to circulate freely for the best cooking results.
- When batch baking one type of food, e.g. Victoria sandwich cakes, those of similar size will be cooked in the same time.
- It is recommended that when baking larger quantities the shelf positions should be evenly spaced to suit the load being cooked. A slight increase in cooking time may be necessary.
- Do not place baking trays directly on the oven base as it interferes with the oven air circulation and can lead to base burning; use the lower shelf position.

Hints and tips when defrosting

- Place the frozen food in a single layer where possible and turn it over half way through the defrosting process.
- The actual speed of defrosting is influenced by room temperature. On warm days defrosting will be faster than on cooler days.
- It is preferable to thaw fish, meat and poultry slowly in the fridge. However, this process can be accelerated by using the defrost function. Small or thin fish fillets, frozen peeled prawns, cubed or minced meat, liver, thin chops, steaks etc., can be thawed in 1 – 2 hours.
- A 1 kg/2¼lb oven ready chicken will be thawed in approximately 5 hours. Remove the giblets as soon as possible during the thawing process.
- Joints of meat up to 2kg/4½lb in weight can be thawed using the defrost function.
- All joints of meat and poultry must be thawed thoroughly before cooking.
- Always cook thoroughly immediately after thawing.
- Do not leave food at room temperature once it is defrosted. Cook raw food immediately or store cooked food in the fridge, once it has cooled.

What to do if...

Please carry out the following checks on your appliance before calling a Service Engineer. It may be that the problem is a simple one which you can solve yourself without the expense of a service call.

In-guarantee customers should make sure that the checks have been made as the engineer will make a charge if the fault is not a mechanical or electrical breakdown.

Please note that proof of purchase is required for in-guarantee service calls.

PROBLEM	POSSIBLE SOLUTION
The grill, ovens and timer do not work.	Check that the appliance has been wired in to the appliance supply and is switched on at the wall. Check that the main appliance fuse is working.
	If you have checked the above: Allow the appliance to cool for a couple of hours. The appliance should now be working normally.
The grill and top oven work but the main oven does not.	Check that the time of day has been set on the clock. Check that the oven is set for manual cooking.
The grill does not work or cuts out after being used for a long period of time.	Ensure the cooling fan is running when the grill is on. If the cooling fan fails, the grill will not operate correctly. Contact your local service force centre.
	Leave the grill door open and allow the grill to cool. After a couple of hours check that the grill works as normal
The timer does not work.	Check that the instructions for the operation of the timer are being closely followed.
The indicator neons are not working correctly.	Check that you have selected only the function you require. Ensure all other controls are in the off position.

What to do if continued...

PROBLEM	POSSIBLE SOLUTION
The oven is not cooking evenly.	Check that the appliance is correctly installed and is level.
	Check that the recommended temperatures and shelf positions are being used.
The oven light fails to illuminate.	The oven light bulb may need replacing.
	If the Main Oven is set for automatic cooking the light will illuminate when the cook time begins.
The oven fan is noisy.	Check that the oven is level.
	Check that the shelves and bakeware are not vibrating in contact with the oven back panel.
The oven temperature is too high or too low.	Check that the recommended temperatures and shelf positions are being used. Be prepared to adjust the temperature up or down slightly to achieve the results you want.

Care and cleaning



Before cleaning always allow the appliance to cool down before switching off at the electricity supply.

Cleaning materials

Before using any cleaning materials on your appliance, check that they are suitable and that their use is recommended by the manufacturer.

Cleaners that contain bleach should not be used as they may dull the surface finishes. Harsh abrasives and scourers should also be avoided.

Cleaning the outside of the appliance

Do not use abrasive cleaning materials e.g. abrasive cream cleaners, wire wool pads or scourers on painted or printed finishes as damage may occur.

Regularly wipe over the control panel, control knobs, handles, doors and appliance sides using a soft cloth and hot soapy water. To prevent streaking, finish with a soft cloth.

Stainless Steel cream cleaners are abrasive and should be avoided as they may dull the surface finish. **Any spillage on the stainless steel finish must be wiped off immediately.**



Do not attempt to remove any of the control knobs from the appliance as this may cause damage and is a safety hazard.

Removing and replacing the wirework runners

1. Remove all shelves and furniture from the oven.
2. Hold the wirework at the bottom, unclip from the cavity side and gently pull towards the centre of the oven.
3. Unhook the runner at the top and remove from the cavity.
4. To replace the runners, hook the wirework side runner into the cavity, slide back and press into place.

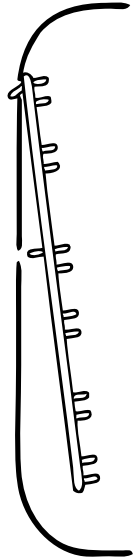

Ensure the wirework runners are firmly in position before replacing the oven shelves.

Cleaning the shelves, wire-work runners and grill/oven furniture

All removable parts, except the grill pan handle can be washed in the dishwasher.

The grill pan, grill pan grid, oven shelves and wirework runners may be cleaned using a soap impregnated steel wool pad. Soaking first in hot soapy water will make cleaning easier.

Cleaning inside the grill and oven compartments

The sides and back of the grill/top oven and main oven compartments are coated with a special Stay-clean coating. They should not be cleaned manually.

The vitreous enamel main oven base and grill compartment base can be cleaned using normal oven cleaners with care. Ensure that the manufacturers instructions are followed and that all parts are well rinsed afterwards.



Aerosol cleaners must not come into contact with elements, the door seal, or any painted finishes as this may cause damage.



Aerosol cleaners must not be used on Stay-clean surfaces.

- To carry out the cleaning cycle, remove the oven shelves and set the oven to max which is the cleaning setting.
- It is a good idea to run the oven for an hour or two per week to ensure continued good performance from the Stay-clean finish.
- Slight discolouration and polishing of the Stay-clean surfaces may occur in time. This does not affect the Stay-clean properties in any way.
- Use minimal, if any, extra oil or fat when roasting meat, potatoes only require brushing with fat before cooking. Extra fat in the oven during roasting will increase splashing and staining of the cavity.
- It is not necessary to add water to a meat tin when roasting. The water and the fat juices from the joint create excessive splattering during cooking – even at normal temperatures, as well as causing condensation.
- Covering joints during cooking will also prevent splashing onto the interior surfaces. Removing the covering for the last 20-30 minutes will allow extra browning if required.

Cleaning the door(s)



Under no circumstances should the door assembly be detached from the product for cleaning.



To prevent damaging or weakening the door glass panels avoid the use of the following:

- **Household detergents and bleaches**
- **Soap impregnated pads unsuitable for non-stick saucepans.**
- **Abrasive cleaning pads, scourers and steel wool pads.**
- **Chemical oven pads or aerosols.**
- **Rust removers.**
- **Bath/Sink stain removers.**

Cleaning between the outer and inner door glass

The door glass is removable for cleaning.

Clean the outer and inner glass using hot soapy water or hob cleaner may be used. Do not use hob cleaner on the Stainless Steel or painted finishes.

Ensure that all parts are well rinsed and thoroughly dried before attempting to replace the glass.

To remove the door glass

1. Open the oven door slightly to gain access to the two cross head screws on the top of the oven door.
2. Loosen the two screws using a Pozidrive screwdriver.
3. Hold the door glass securely in place with one hand before removing the screws and washers completely with the other hand. The screws and washers retain the trim on the top of the grill door. Note the position of the trim on the door.

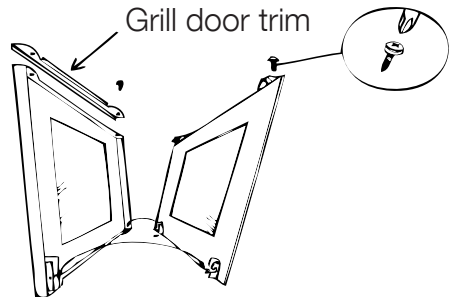

4. Holding the door and glass with one hand, gently pull towards you and slightly lift the door glass with the other hand to disengage the panel from the location point at the bottom of the door. Gently release the door to close it.
5. Clean the outer and inner glass using hot soapy water or hob cleaner may be used. Do not use hob cleaner on the Stainless Steel or painted finishes. Do not try to clean the foil, which is inside the door. The foil is there to help keep the door cool, if it is damaged it will not work. Ensure that all parts are well rinsed and thoroughly dried before attempting to replace the outer door.



If the door glass panel becomes chipped or has deep scratches the glass will be weakened and must be replaced to prevent the possibility of the panel shattering. Please contact your local service force centre who will be pleased to advise further.

To replace the outer door glass

1. Holding the oven glass with both hands, gently place the locators into the holes of the brackets at the bottom of the oven door.
2. Holding the door glass with your left hand, use your right hand to open the oven door. Bring the door gently towards the glass panel ensuring the screw location holes line up.
3. Place the trim in the correct position on the top of the grill door.
4. Hold the glass in place with one hand and insert the crosshead screws with washers into the location holes with the other hand. Give the screws one turn to ensure the glass is secure.
5. Tighten the screws positively with a Pozidrive screwdriver before closing the oven door.



Do not attempt to use the oven without the glass being in place.

Replacing an oven light bulb

The type of bulb required is a 300°C 25 watt small Edison Screw.



Disconnect the appliance from the electricity supply before replacing the bulb.

1. Make sure the appliance is cool before replacing the bulb.
2. Open the oven door and remove the shelves and wirework runners.
3. Pull the glass bulb cover towards you and then pull it off. If necessary, use a screwdriver to carefully lever off the cover, taking care not to damage the oven cavity.
4. Unscrew the bulb by turning it to the left.
5. Fit a new bulb and then replace the glass bulb cover.
6. Refit the wirework runners and replace the shelves.
7. Restore the electricity supply.

Place palm at top of lens flat against oven side

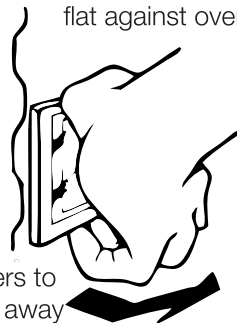

Use fingers to lever lens away from housing

Technical data

Voltage:	230-240 Volts AC 50Hz
Wattage:	4.9 - 5.3 kW
Height:	720mm
Width:	600mm
Depth: (excluding handles and knobs)	600mm
Weight	50kg

This appliance complies with:
European Council Directive 73/23/EEC
EMC Directive 89/336/EEC
CE Marking Directive 93/68/EEC
Energy Label Directive 2002/40/EC

Installation



- This appliance must be installed by a qualified electrician/competent person. Safety may be impaired if installation is not carried out in accordance with these instructions.
- This appliance must be earthed.
- Do not remove the screws from the earth tab extending from the oven mains terminal block.

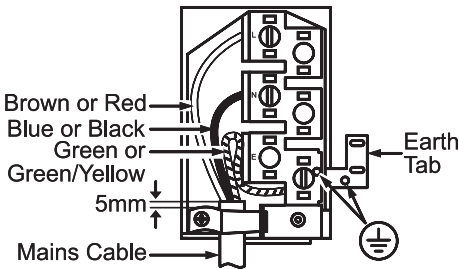

- Before connecting the appliance make sure that the voltage of your electricity supply is the same as that indicated on the rating plate. This is situated on the lower front frame of the appliance and can be seen upon opening the door. Alternatively the rating plate may also be found on the back or top of some models (where applicable).
- Do not alter the electrical circuitry of this appliance.

Things to note

- This appliance is designed to be fitted in cabinets of the recommended dimensions as shown.

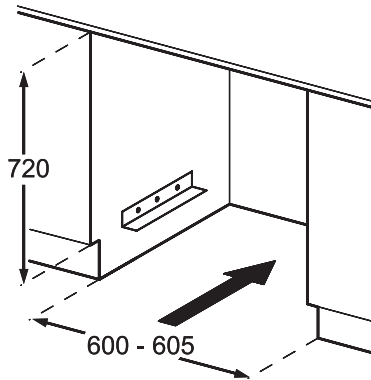
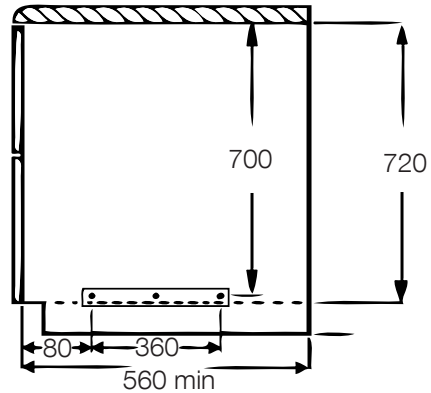

- If there is an existing housing unit it must be removed.
- The dimensions given provide adequate air circulation around the unit within the cabinet, ensuring compliance with BS EN60-335.
- The appliance must not be installed on a wooden base board.
- Enquiries regarding the installation of the cooker point, if required, should be made to your Regional Electricity Company to ensure compliance with their regulations.

- The appliance socket switch should be outside the cabinet but within 2m of the appliance to make it accessible to switch off the appliance in case of an emergency.
- To protect the hands, wear gloves when lifting the oven into its housing.



Do not lift the appliance by the handles.

Note: House circuit

Earth leakage and continuity tests must be carried out before the appliance is connected to the mains supply and re-checked after fitting.

Choice of electrical connection

- The appliance should be operated using at least 6mm² twin core and earth PVC insulated multilayer cable. Please choose from the most appropriate after reading the different methods:-
- By connecting the appliance to a cooker point (having a double pole isolating switch with at least 3mm contact separation in all poles) and protected with a fuse or miniature circuit breaker at your mains fuse box.
- If you wish to connect an oven and a hob to a cooker point you can. Oven and hob units should be separately connected to a cooker point.

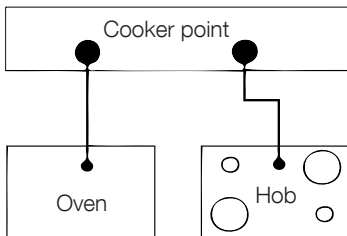

Note: It is good practice to :

- Fit an Earth Leakage Circuit Breaker to your house wiring.
- Wire your appliance to the latest IEE regulations.

Preparing cabinet for fitting of oven

- Make sure the space between the cabinets is the correct size for the appliance to be fitted.
- The plinth board spanning the space into which the appliance is to be installed should be removed.
- If the size is between adjacent cabinets is 605-610mm, then the cabinets should be modified so that the recommended dimension of at least 600-605mm is maintained. The modification should ideally be localised to ensure that after screw fitting the oven is securely fixed into position.
- The cabinets must be stable and level by firmly securing it to the wall or floor. If necessary, make arrangements to ensure the shelf upon which the oven will rest is level.
- The adjacent cabinets must be stable and level by firmly securing to the wall or floor. If necessary, make arrangements to ensure the work surface below which the oven will rest is level.
- Drill two pilot screw holes into the sides of the adjacent cabinets, in the positions indicated.

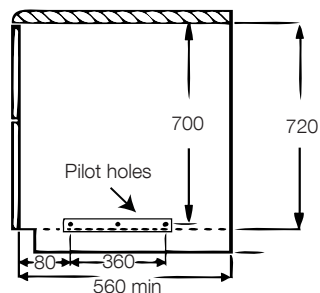

32 electrolux installation

- Fit the appliance mounting brackets using the two holes indicated to the adjacent cabinets.

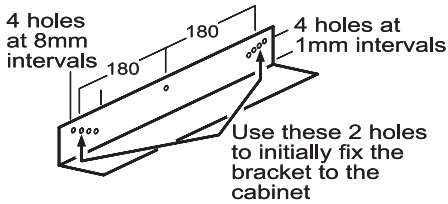

- Check that the mounting brackets are level. They can be adjusted if necessary by using the extra holes at the ends of the brackets. Once the brackets are level, drill a pilot hole through the central hole in the bracket and fit the remaining screw.

How to finish unpacking

- Place packed appliance next to the space in which it will be installed.
- Remove the appliance packing except for bottom tray, which should be left in position until the appliance is ready to be fitted into its cabinet.
- **NOTE: It is imperative that the appliance is left in the base to protect both the appliance and the floor.**
- Ensure the user is given these operating instructions.



Important: Switch off at the mains, miniature circuit breaker and if appropriate, remove fuse before commencing any electrical work.

To remove cover of mains terminal

From the rear of the appliance, remove mains input terminal cover to gain access to terminal block.

- First remove retaining screw with pozidrive screwdriver.

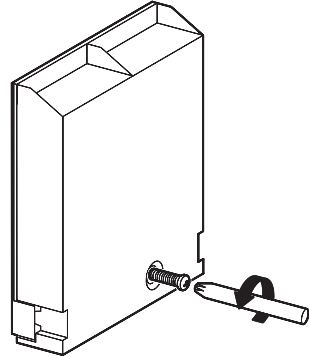

- Prise cover loose using screwdriver in position (1) then lever off with screwdriver in position (2) at either side.

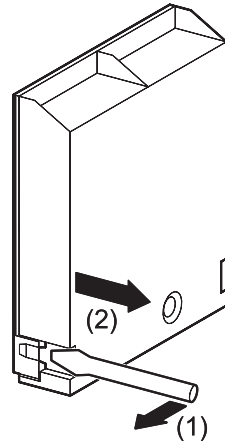

- Lift cover and remove screw from cable clamp.

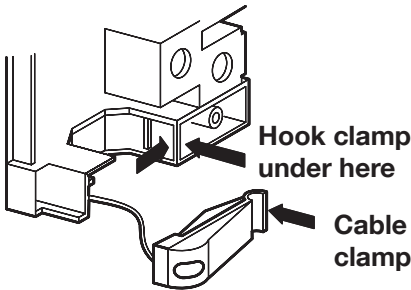

Connecting to the mains terminal



Warning: This appliance must be earthed.

- We recommend you use a new length of 6mm² twin core and earthed cable to ensure your safety.
- Make connection as shown by proceeding as follows:-

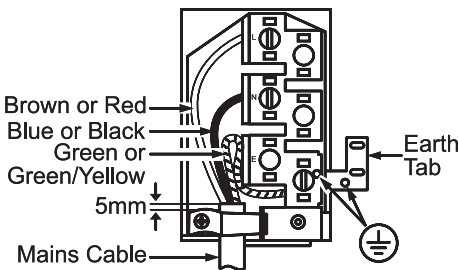

- Preform wires to the appropriate shape to suit fitting into the mains terminal block.
- Strip inner insulation on wires using wirestrippers.
- Twist the bared wires using pliers.
- Cut bared wires 10mm away from the end of the inner insulation. Where

uninsulated Earth wires are used ensure they are suitably sheathed to leave 10mm bare wire to fit into the terminal.

- Clamp bare wires into the relevant terminal and check they are held by tugging each one in turn.
- Clamp the mains cable securely ensuring 5mm of the outer insulation is inside the terminal block and that the wires are not taut but not so slack as to cause any fouling. See diagram.
- Place fuse/miniature circuit breaker in circuit and switch on at mains.

Checking electrical connections

Correct electrical connection can be confirmed when switching on the appliance and setting the grill.

Note: House circuit

Earth leakage and continuity tests must be carried out before the appliance is connected to the mains supply and re-checked after fitting.

Connecting to a hob or cooker point

- Either follow in general terms the instructions for connecting to the terminal block or refer to the hob suppliers installation instructions.



Feed the cable through the cabinet and arrange to route the cable away from the appliance which may become hot.

Fitting into the space between cabinets



IMPORTANT: Ensure that the oven is switched off at the wall before any further work is carried out.

34 electrolux installation

- Position the appliance in front of the cabinet.

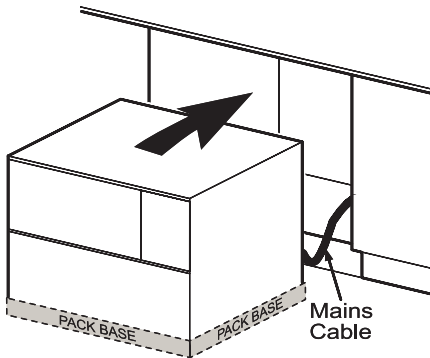

- Take out all oven furniture before installation to reduce the weight you need to lift. The oven door should be taped to keep it closed whilst lifting.
- To place the appliance into the space between cabinetry follow the procedure below:



Two people will be required to carry out the lifting procedure.



Warning: Do not attempt to lift this appliance by the handle(s).

- Each person should squat either side of the appliance.
- Tilt the appliance so that your hands can support the underside of the appliance.
- Keeping your back straight raise the appliance to the correct height by straightening at the knees.
- Rest the rear underside of the appliance on the mounting brackets while your hands support the front.

- The appliance can be pushed fully into the space. Take care to avoid fouling the mains lead.
- Ensure the appliance is central and level.
- When the appliance is fully housed, screw the stability screws (supplied with the appliance) into the underside of the worksurface in the positions indicated, taking care not to distort the trim. It is advisable to turn each screw alternatively to avoid damaging the trim.

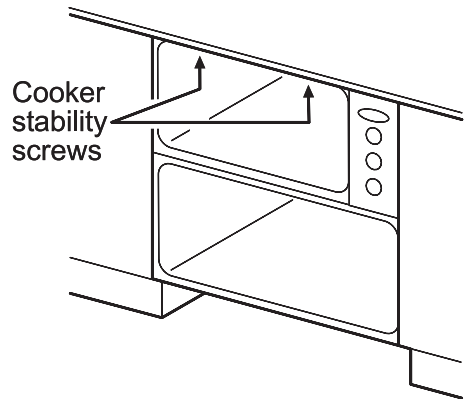

- Place the heat deflector flush with the edge of the worksurface, with the cork spacers up over and screw into position using the screws supplied with the appliance. Failure to do this may cause damage to the work surface

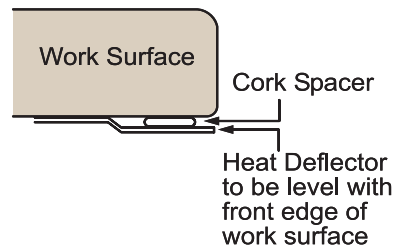

- Replace the plinth board.
- Switch on the appliance and refer to the operating instructions.

Environment



After installation please dispose of the packaging with due regard for safety and the environment. Your local authority can arrange this.

At the end of the appliances life

The symbol  on the product or on its packaging indicates that this product may not be treated as household waste. Instead it shall be handed over to the applicable collection point for the recycling of electrical and electronic equipment. By ensuring this product is disposed of correctly, you will help prevent potential negative consequences for the environment and human health, which could otherwise be caused by inappropriate waste handling of this product. For more detailed information about recycling of this product, please contact your local city office, your household waste disposal service or the shop where you purchased the product.

Energy save mode

By switching off the time display you can save energy.

Switching off the time display

Press and hold any two buttons until the display switches off.

Switching on the time display

Press any button to switch on the display.



The display can only be switched off if none of the timer functions, 'Cooktime', 'Endtime', or 'Countdown', is in use.

Guarantee / Customer care

Standard guarantee conditions

We, Electrolux, undertake that if within 12 months of the date of the purchase this Electrolux appliance or any part thereof is proved to be defective by reason only of faulty workmanship or materials, we will, at our option repair or replace the same FREE OF CHARGE for labour, materials or carriage on condition that:

- The appliance has been correctly installed and used only on the electricity supply stated on the rating plate.
- The appliance has been used for normal domestic purposes only, and in accordance with the manufacturer's instructions.
- The appliance has not been serviced, maintained, repaired, taken apart or tampered with by any person not authorised by us.
- Electrolux Service Force Centre must undertake all service work under this guarantee
- Any appliance or defective part replaced shall become the Company's property.
- This guarantee is in addition to your statutory and other legal rights.

Exclusions

- Damage or calls resulting from transportation, improper use or neglect, the replacement of any light bulbs or removable parts of glass or plastic.
- Costs incurred for calls to put right an appliance which is improperly installed or calls to appliances outside the United Kingdom.
- Appliances found to be in use within a commercial environment, plus those which are subject to rental agreements.
- Products of Electrolux manufacturer that are not marketed by Electrolux

Service and Spare Parts

In the event of your appliance requiring service, or if you wish to purchase spare parts, please contact your local Service Force Centre by telephoning

0870 5 929 929

Your telephone call will be automatically routed to the Service Force Centre covering your postcode area.

For the address of your local Service Force Centre and further information about Service Force, please visit the website at

www.serviceforce.co.uk

Before calling out an engineer, please ensure you have read the details under the heading "Something not working" When you contact the Service Force Centre you will need to give the following details:

1. Your name, address and postcode.
2. Your telephone number.
3. Clear concise details of the fault.
4. The model and Serial number of the appliance (found on the rating plate).
5. The purchase date.

Please note a valid purchase receipt or guarantee documentation is required for in guarantee service calls.

Customer Care

For general enquiries concerning your Electrolux appliance, or for further information on Electrolux products please contact our Customer Care Department by letter or telephone at the address below or visit our website at www.electrolux.co.uk

Customer Care Department
Electrolux Major Appliances
Addington Way
Luton
Bedfordshire, LU4 9QQ
Tel: 08705 950 950 (*)

(*) Calls may be recorded for training purposes

European guarantee

This appliance is guaranteed by Electrolux in each of the countries listed below for the period specified in the appliance guarantee or otherwise by law. If you move from one of these countries to another of the countries listed below the appliance guarantee will move with you subject to the following qualifications: -

- The appliance guarantee starts from the date you first purchased the appliance which will be evidenced by production of a valid purchase document issued by the seller of the appliance.
- The appliance guarantee is for the same period and to the same extent for labour and parts as exists in your new country of

residence for this particular model or range of appliances.

- The appliance guarantee is personal to the original purchaser of the appliance and cannot be transferred to another user.
- The appliance is installed and used in accordance with instructions issued by Electrolux and is only used within the home, i.e. is not used for commercial purposes.
- The appliance is installed in accordance with all relevant regulations in force within your new country of residence.

The provisions of this European Guarantee do not affect any of the rights granted to you by law.

www.electrolux.com

		
Albania	+35 5 4 261 450	Rr. Pjeter Bogdani Nr. 7 Tirane
Belgique / België / Belgien	+32 2 363 04 44	Bergensesteenweg 719, 1502 Lembeek
Česká republika	+420 2 61 12 61 12	Budějovická 3, Praha 4, 140 21
Danmark	+45 70 11 74 00	Sjællandsgade 2, 7000 Fredericia
Deutschland	+49 180 32 26 622	Muggenhofer Str. 135, 90429 Nürnberg
Eesti	+37 2 66 50 030	Mustamäe tee 24, 10621 Tallinn
España	+34 902 11 63 88	Carretera M-300, Km. 29,900 Alcalá de Henares Madrid
France	www.electrolux.fr	

		
Great Britain	+44 8705 929 929	Addington Way, Luton, Bedfordshire LU4 9QQ
Hellas	+30 23 10 56 19 70	4, Limnou Str., 54627 Thessaloniki
Hrvatska	+385 1 63 23 338	Slavonska avenija 3, 10000 Zagreb
Ireland	+353 1 40 90 753	Long Mile Road, Dublin 12
Italia	+39 (0) 434 558500	C.so Lino Zanussi, 26 - 33080 Porcia (PN)
Latvija	+37 17 84 59 34	Kr. Barona iela 130/2, LV-1012, Riga
Lituania	+370 5 27 80 609	Verkiu 29, 09108 Vilnius, Lithuania
Luxembourg	+35 2 42 43 13 01	Rue de Bitbourg, 7, L-1273 Hamm
Magyarország	+36 1 252 1773	H-1142 Budapest XIV, Erzsébet királyné útja 87
Nederland	+31 17 24 68 300	Vennootsweg 1, 2404 CG - Alphen aan den Rijn
Norge	+47 81 5 30 222	Risløkkvn. 2, 0508 Oslo
Österreich	+43 18 66 400	Herziggasse 9, 1230 Wien
Polska	+48 22 43 47 300	ul. Kolejowa 5/7, Warsaw
Portugal	+35 12 14 40 39 39	Quinta da Fonte - Edificio Gonçalves Zarco - Q 35 -2774-518 Paço de Arcos
Romania	+40 21 44 42 581	B-dul Timisoara 90, S6, Bucharest
Schweiz - Suisse - Svizzera	+41 62 88 99 111	Industriestrasse 10, CH-5506 Mägenwil
Slovenija	+38 61 24 25 731	Tržaška 132, 1000 Ljubljana
Slovensko	+421 2 43 33 43 22	Electrolux Slovakia s.r.o., Electrolux Domáce spotrebiče SK, Seberínho 1, 821 03 Bratislava
Suomi	+35 8 26 22 33 00	Konepajaranta 4, 28100 Pori
Sverige	+46 (0) 771 76 76 76	Electrolux Service, St Göransgatan 143, S-105 45 Stockholm
Türkiye	+90 21 22 93 10 25	Tarlabası caddesi no: 35 Taksim İstanbul
Россия	+7 095 937 7837	129090 Москва, Олимпийский проспект, 16, БЦ "Олимпик"

www.electrolux.com

www.electrolux.co.uk