

User manual

Cooker

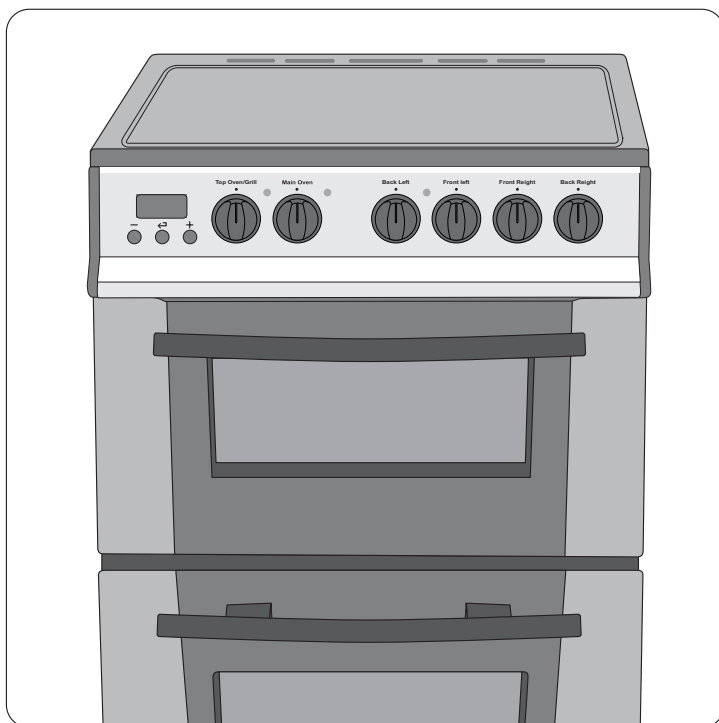

ZKS5010
ZKC5020
ZKC5030

Thank you for selecting our appliance

We wish you lots of enjoyment with your new appliance and we hope that you will consider our brand again when purchasing household appliances.

Please read this user manual carefully and keep it throughout the product life cycle as a reference document. The user manual should be passed on to any future owner of the appliance.

Contents

Safety instructions _____	3	The main oven _____	16
Description of the appliance _____	5	Cooking tables _____	18
Before first use _____	7	Care and cleaning _____	21
Grill and oven furniture _____	8	What to do if... _____	25
The electronic timer (ZKC5030W1/S1/X1/ K1) _____	9	Installation _____	26
The hob _____	10	Technical Data _____	28
The grill (ZKS5010W1/S1/B1-ZKC5020S1/ W1/X1) _____	13	Environmental Information _____	29
The top oven (ZKC5030W1/S1/X1/ K1) _____	14	Guarantee/Customer Service _____	29
		European Guarantee _____	31
		www.electrolux.com _____	31

Subject to change without notice

Safety instructions

General safety

These warnings are provided in the interest of your safety. Ensure that you understand them all before installing or using the appliance. Your safety is of paramount importance. If you are unsure about any of the meanings of these warnings please contact customer care.

Installation

- The appliance must be installed according to the instructions supplied.
- The installation work must be undertaken by a qualified electrician or competent person.
- The appliance should be serviced by an authorised service engineer and only genuine approved spare parts should be used.
- The appliance must be installed in an adequately ventilated room.
- If the appliance is to be placed on a base, measures must be taken to prevent the appliance from slipping.
- This appliance is heavy and care must be taken when moving it.
- Do not attempt to lift or move this appliance by the handles.
- All packaging, both inside and outside the appliance must be removed before the appliance is used.
- It is dangerous to alter the specifications or modify the appliance in any way.

Child safety

- Do not allow children to play with any part of the packaging.
- Do not allow children to sit or climb on the drop down doors.
- Children should be supervised to ensure that they do not play with the appliance.

WARNING!

Accessible parts may be hot during use. Young children should be kept away.

During use

- This appliance is not intended for use by children and other persons whose physical, sensory or mental capabilities or lack of experience and knowledge prevents them from using the appliance safely without supervision or instruction by a responsible person to ensure that they can use the appliance safely.
- This appliance is not intended to be operated by means of an external timer or separate remote control system.
- This appliance has been designed for domestic use to cook edible foodstuffs only and must not be used for any other purposes.
- Take great care when heating fats and oils, as they will ignite if they become too hot.
- Never place plastic or any other material, which may melt in or on the oven.
- Do not leave the grill pan handle in position when grilling, as it will become hot.
- Always support the grill pan when it is in the withdrawn or partially withdrawn position.

- Always use oven gloves to remove and replace the grill pan handle when grilling.
- Always use oven gloves to remove and place food in the oven.
- Ensure cooking utensils are large enough to contain foods to prevent spillage and boil over.
- The handles of saucepans, which are smaller than the heated area on the hob, will become hot.
- Ensure your hand is protected before handling the pan.
- Do not use the appliance if the ceramic glass is damaged. If a fault or crack becomes visible, disconnect the appliance immediately from the electricity supply and contact your local service force centre.
- Do not place foil or plastic containers on the ceramic glass.
- During use the appliance becomes hot. Care should be taken to avoid touching heating elements inside the oven.
- Ensure that all vents are not obstructed to ensure ventilation of the oven cavity.
- Never line any part of the appliance with foil.
- Always stand back from the appliance when opening the doors to allow any build up of steam or heat to release.
- Some parts of the product may preserve their heat for a long time; please wait until the parts primarily exposed to heat cool down before touching them.
- Do not keep flammable materials close while the product is operating.
- Do not leave anything on the oven door when it is open.
- Always switch the cooker off when you do not use it.

WARNING!

Never leave the appliance unattended when the oven door is open.

- Do not place sealed cans or aerosols inside the oven. They may explode if they are heated.
- Ensure that all control knobs are in the off position when not in use.
- Do not stand on the appliance or on the open oven doors.
- Do not hang towels, dishcloths or clothes from the appliance or its handles.
- Do not use this appliance if it is in contact with water.
- Never operate it with wet hands.

Cleaning and maintenance

WARNING!

For hygiene and safety reasons this appliance should be kept clean at all times. A build-up of fat or other foodstuff could result in a fire especially in the grill pan.

- Do not leave the cookware containing foodstuff, e.g. fat or oil in the appliance in case it is inadvertently switched on.
- Extreme care must be taken when using a ceramic hob scraper.
- Always allow the appliance to cool before switching off at the wall prior to carrying out any cleaning/maintenance work.
- Only clean this appliance in accordance with the instructions given in this book.
- Never use steam or high-pressure steam cleaners to clean the appliance.

Description of the appliance

Product description

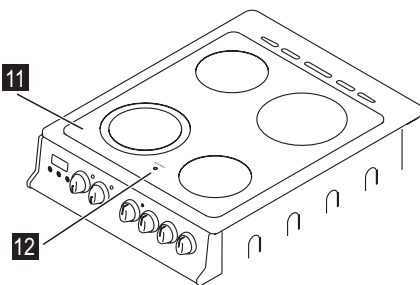
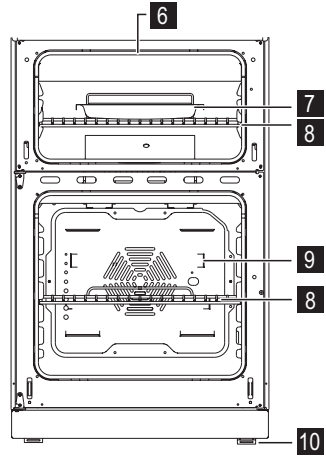
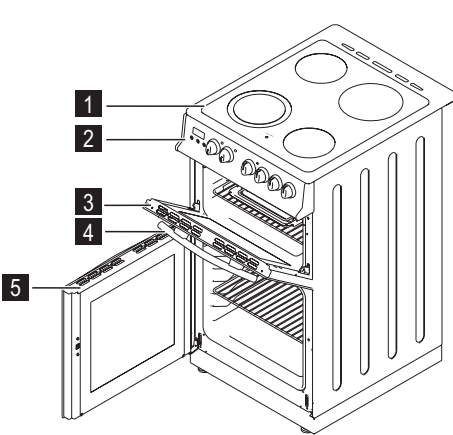

- 1 Hob
- 2 Control Panel
- 3 Top Oven Door/Grill
- 4 Oven Door Handle/Grill
- 5 Main Oven Door
- 6 Tubular heating element
- 7 Grill Pan
- 8 Shelf
- 9 Levelling leg
- 10 Ceramic feet
- 11 Hot hob indicator

Controls and their functions

ZKS5010W1/S1/B1, ZKC5020S1/W1/X1

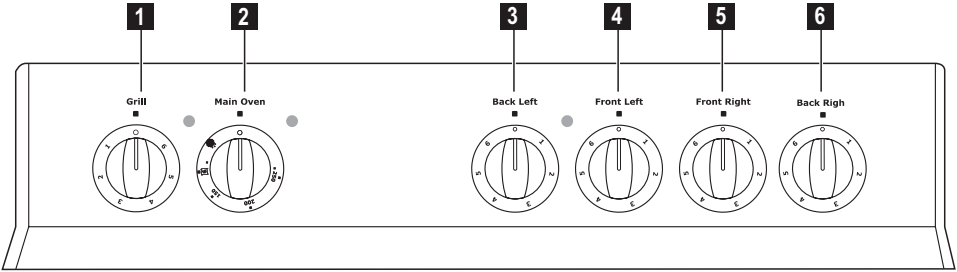

- 1** Grill
- 2** Main Oven
- 3** Back Left
- 4** Front Left
- 5** Front Right
- 6** Back Right

ZKC5030W1/S1/X1/K1

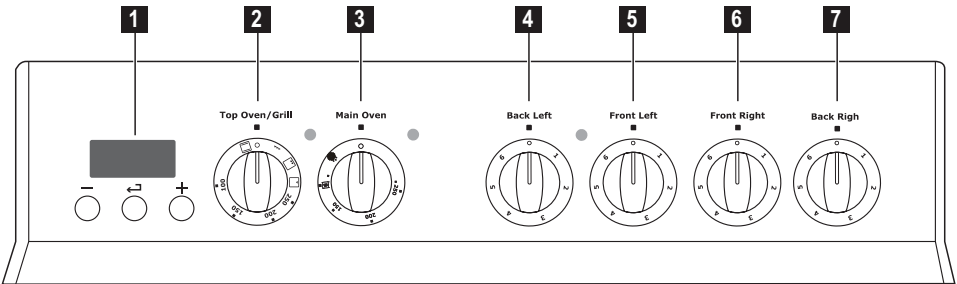

- 1** Timer
- 2** Top Oven/Grill
- 3** Main Oven
- 4** Back Left
- 5** Front Left
- 6** Front Right
- 7** Back Right

Before first use

Rating plate

- This is situated on the lower front frame of the appliance and can be seen upon opening the door. Alternatively the rating plate may also be found on the back or top of some models (where applicable).
- The appliance must be protected by a suitably rated fuse or circuit breaker.
- The rating of the appliance is given on the rating plate.
- **Do not remove the rating plate from the appliance as this may invalidate the guarantee.**

Preparing to use your appliance

- Carefully check whether there is any damage after you unpack the appliance. If there is any defect; do not use the appliance and contact your retailer immediately. As the materials used for packaging (nylon, stapler, Styrofoam etc.) may cause harmful effects to children, they should be collected and removed immediately.
- For your safety wall coverings at the rear of the appliance should be securely fixed to the wall.
- Wipe over the base of the oven(s) with a soft cloth using hot soapy water. Wash the oven furniture before use.
- We suggest that you run the oven(s) and grill for 10 – 15 minutes at maximum temperature, to burn off any residue from their sur-

faces. Accessible parts may become hotter than in normal use. Children should be kept away. During this period an odour may be emitted, it is therefore advisable to open a window for ventilation.

Control panel indicator neon(s)

- The indicator neon will operate when the grill (where applicable) or oven(s) is switched on. The indicator neon will glow. It may turn on and off during use to show that the setting is being maintained. If the neon does not operate as the instructions indicate the controls have been incorrectly set. Return all controls to zero and reset following the instructions for the required setting.

Condensation and steam

- When food is heated it produces steam similar to a boiling kettle. The vents allow some of this steam to escape. However, always stand back from the appliance when opening the door(s) to allow any build up of steam or heat to release.
- If the steam comes into contact with a cool surface on the outside of the appliance, e.g. a trim, it will condense and produce water droplets. This is quite normal and is not caused by a fault on the appliance.
- To prevent discolouration, regularly wipe away condensation and foodstuff from surfaces.

- For your safety wall coverings at the rear of the appliance should be securely fixed to the wall.

- Do not use baking trays larger than 30cm x 35cm (12" x 14") as they will restrict the circulation of heat and may affect performance.

Cookware

- Baking trays, dishes etc., should not be placed directly against the grid covering the fan at the back of the oven.

Grill and oven furniture

- The following items of grill and oven furniture have been supplied with the appliance. If you require replacements of any of the items listed below please contact your local service force centre.

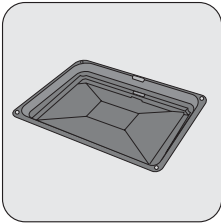

1 grill pan

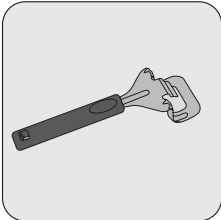

1 grill pan handle

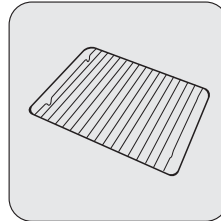

1 grill pan grid

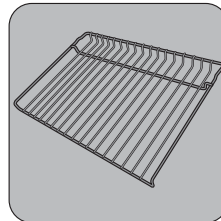

1 straight shelf (For grilling and top oven cooking)
and
2 straight shelves (For main oven cooking)

The electronic timer (ZKC5030W1/S1/X1/K1)

This oven has a 24-hour clock. In the event of an interruption of the electricity supply, the

clock will stop and you will not be able to use the main oven.

To set the time of day

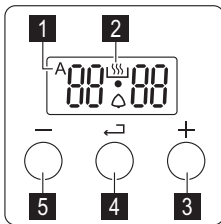

1. This symbol is displayed when the Cooking Period function is set (see appropriate chapter)
2. This symbol is displayed when the Cooking Period function is set (see appropriate chapter)
3. Time increase button
4. Mode button
5. Time decrease button

“A” Symbol and "0:00" will flash after the cooker is connected to electricity. Press (+) and (-) keys at the same time. Press the increase and decrease buttons until the correct time is showing.

IMPORTANT!

The increase and decrease control buttons operate slowly at first and then more rapidly. They should be pressed separately.

period an alarm is heard and “🔔” symbol flashes. You can press any key to stop the alarm.

To set the countdown

This function can be used as time set up and alarm when wished. “Mode”(↩) key must be pressed until “🔔” indicator lamp will start to light. The wished period interval is adjusted via “+” and “-” keys. Screen reverts to the time of day and “🔔” sign that flashed in the past remains fixed. It is possible to make time set up between 0- 23.59 hours. At the end of cooking

Setting the oven timer control

Only the main oven can be automatically timed. When using the timer control for the very first time, it is advisable to let it operate while you are at home.

The display can be checked to show that it is operating correctly and you will feel confident to leave a meal to cook automatically in the future.

Setting the Desired Cooking Period

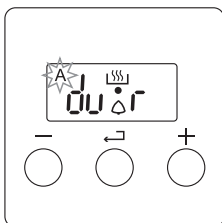

This function is used to set the desired cooking period. To adjust the cooking period, "Mode" (←→)key is pressed until "dur" indicator lamp starts to flash. The desired cooking period is adjusted by using "+" and "-" keys. Once the time is adjusted, it is registered automatically in 5 seconds following the adjustment. "A" and "SSS" symbols will be illuminated. The screen returns to the current time. At the end of a timed cooking period an alarm will sound and "A" and "SSS" symbols starts to flash. Pressing any button stops the alarm and the lamp flashing. It is possible to adjust cooking period between 0-10 hours.

Setting the Finish Time

This function is used to adjust finish time of the cooking period. To adjust the finish time of cooking "Mode" key is pressed until "End" indicator lamp starts to flash. The desired finish

time is adjusted by using "+" and "-" keys. The time will revert to the time of day when the finish time is reached an alarm is heard and you can press any key to stop the alarm. The oven will turn off.

Setting the Cooking Period and Finish Time

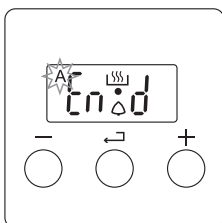

This function is used to adjust the cooking period by use of the automatic cooking function. Both cooking period and end time have to be adjusted. The cooking period is adjusted as explained above. "Mode" key is pressed until "End" indicator lamp flashes in order to adjust the ending time. "+" and "-" keys must be used. Once the time is adjusted, it is registered automatically in 5 seconds following the adjustment and "A" and "SSS" symbols starts to light continuously. The screen returns to the current time. An alarm sound is heard at the end of the time and "A" symbol starts to flash. Pressing any button stops the alarm and lamp flashing.

The hob

WARNING!

Only for the ceramic hob models: Do not use the appliance if the ceramic glass is damaged. If a fault or crack becomes visible, disconnect the appliance immediately from the electricity supply and contact your local service force centre.

The highest number represents the hottest setting and the lowest number represents the coolest setting. Choose a setting appropriate to the quantity and type of food to be cooked.

Using the hob

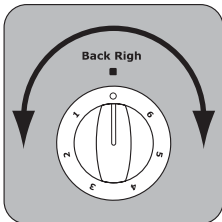

The hob part of the appliance is controlled via a knob with 7 positions on the control panel. Position "0" means off position. The remaining 6 positions indicate the following types of use:

- 1: Heat maintenance position
- 2-3: Heating in low temperature position
- 4-5-6: Cooking, frying and boiling position

The knob rotation direction may differ according to the product specification. In case of ZKS5010 models surfaces of hotplates are covered by a protective layer. At first use, operate the hotplates without a pan at level 3 for 5 minutes. This hardens the protective coating on the hob and

makes it more resistant to normal use. A harmless smoke will be given off from the hob.

Recommended saucepans

- Only saucepans with flat bases and close fitting lids are recommended. The saucepan base should be approximately the same size as the cooking area.
- Ensure that new saucepans are well scrubbed to remove edges and take off any deposits left from manufacture.
- Traditional round-bottomed Woks must not be used even with a stand. Woks with flat-bottomed bases are available and do comply with the above recommendations.

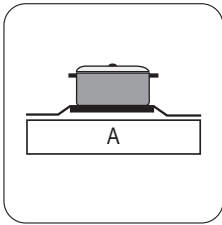

A - Right

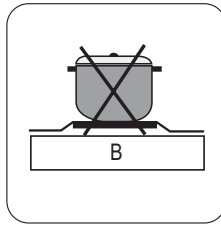

B - Wrong: circular saucepan base

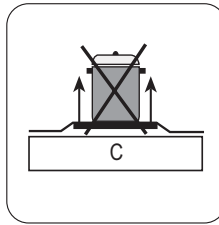

C - Wrong: small saucepan diameter

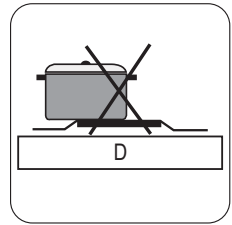

D - Wrong: saucepan base not central

IMPORTANT!

A ceramic glass hob may occasionally switch on and off when higher heat settings are used. This is due to a safety device, which prevents the glass from overheating.

- Some switching on and off when cooking at high temperatures, e.g. deep fat frying is quite normal, causes no damage to the hob and little delay in cooking times.
- Excessive switching may however be caused by the use of an unsuitable saucepan or a saucepan which is smaller than the heated area. If excessive switching occurs, discontinue use of the saucepan.

Hints and tips when using the hob

- Lift, rather than slide saucepans on and off the hob. This will reduce the risk of scratches and metal marks from saucepans with aluminium bases. Metal marks can be easily cleaned off providing they are not allowed to burn on.
- Follow any guidelines provided by the saucepan manufacturer, particularly those relating to recommended heat settings.

- Avoid using thin, badly dented or distorted saucepans. Those with uneven bases should not be used.
- Never leave the hob on when not covered with a saucepan.
- Ensure that the hob and saucepans are clean and dry before the start of cooking.
- Follow the cleaning instructions very closely to keep the hob looking like new.
- If spillage occurs with sugar solutions, e.g. jams and syrups, it must be wiped from the hob before it sets and becomes hard otherwise damage to the hob will occur.
- Make sure that the hob is switched off after using it.
- Avoid the use of decorative covers with sold hotplate as they can cause condensation to form on the hotplates which may lead to deterioration.

The grill (ZKS5010W1/S1/B1-ZKC5020S1/W1/X1)

! CAUTION!

Accessible parts may be hot when the grill is in use. Young children should be kept away.

Using the grill

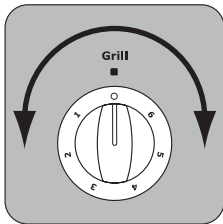

IMPORTANT!

Top oven door can be kept either open or closed during grilling

IMPORTANT!

Description of grill functions may be found in the chapter about the top oven

Turn the grill control to the required setting. At lower settings the grill may turn on and off over time and you may prefer to use these settings to keep food warm. The food will continue to cook gently if the grill is used for this purpose.

- The indicator neon will glow continuously as long as the grill is turned on.
- Some smoke from fat splashes may be evident as the grill cleans itself.

! WARNING!

Never cover the grill pan or grid with foil as this can lead to grill fires.

The grill pan and handle

! WARNING!

Always use an oven glove to protect your hand when using the grill as all the metal parts can become very hot!

The grill pan has a detachable handle. Ensure to locate the tip of grill pan handle inside the recessed form as indicated in the figure below. Do not leave the handle in position when grilling. If the handle is left in position when grilling, it will get very hot.

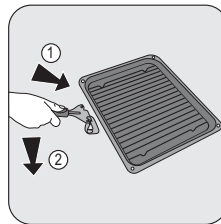

! WARNING!

Ensure the handle is properly located.

! WARNING!

Protect your hands when removing the grill pan handle. Always remove the grill pan handle during grilling. Place the grill pan on the shelf so that the pan is positioned centrally beneath the grill.

Hints and tips

- Most foods should be placed on the grid in the grill pan to allow maximum circulation of air to lift the food out of the fats and juices.

- Adjust the grid and grill pan runner position to allow for different thicknesses of food.
- Food should be thoroughly dried before grilling to minimise splashing. Brush lean meats and fish lightly with a little oil or melted butter to keep them moist during cooking.
- Accompaniments such as tomatoes and mushrooms may be placed underneath the grid when grilling meats.
- When toasting bread use the shelf in position 2 with the grid in the high position.
- When using the centre section grill, ensure food is placed centrally on the grilling grid directly beneath the grill element.
- The food should be turned over during cooking as required.
- Preheat the grill on full setting for a few minutes before sealing steaks or toasting. Adjust the heat setting and the shelf as necessary during cooking.

Grilling chart

FOOD	GRILL TIME (mins in total)
Bacon Rashers	0:10 - 0:15
Beef Burgers	0:15 - 0:20
Chicken Joints	0:40 - 0:50
Lamb Chops	0:20 - 0:30
Pork Chops	0:20 - 0:30
Whole Trout/Mackerel	0:20 - 0:30
Plaice/Cod Fillets	0:15 - 0:25
Kebabs	0:20 - 0:30
Kidneys - Lamb/Pig	0:15 - 0:20
Liver - Lamb/Pig	0:15 - 0:30
Sausages	0:20 - 0:30
Steak - Rare	0:06 - 0:12
Steak - Medium	0:12 - 0:16
Steak - Well Done	0:14 - 0:20
Toasted Sandwiches	0:05 - 0:10

IMPORTANT!

The times quoted above are given as a guide and should be adjusted to suit personal taste.

The top oven (ZKC5030W1/S1/X1/K1)

Using the Top Oven

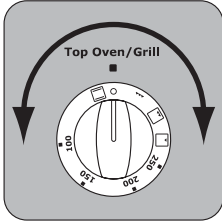

Note that ZKC5030W1/S1/X1/K1 do not have grill function. The switch for the top oven allows you to select the oven functions. The symbols and their functions are briefly explained in the following lines. The detailed information for their usage will also be explained in the following pages.



Grill Function



Double grilling function



Top and bottom heating function

Grill Function

This function is used for grilling. In order to grill, please use the grill pan supplied with your product. Turn your top oven's switch as it will show the sign of this function. For details, please refer to the cooking table.

At the end of grilling, as in all other cooking processes; turn the top oven switch off. Take the grill pan out by using the special handle and put the pan onto a safe place. Keep children away from the hot oven during and after grilling, until it has cooled completely.

Double Grilling Function

This function is used for wider area grilling. In order to grill, please use the grill pan supplied with your product. Turn your top oven's switch as it will show the sign of this function. For details, please refer to the cooking table. At the end of grilling, as in all other cooking processes; turn the top oven switch off. Take the grill pan out by using the special handle and put the pan onto a safe place. Keep children away from the hot oven during and after grilling until, it is cool completely.

Top and Bottom Heating Function

The top oven is the smaller of the two ovens. It is designed for cooking smaller quantities of food. It gives especially good results if used to cook fruitcakes, sweets and savoury flans or quiche. The top oven is also ideal for use as warming compartment to warm dishes and keep food hot. Use the top oven when you want to warm plates. Use the lowest setting on the second oven temperature control.

At the end of cooking period, as in all other cooking processes; turn the top oven switch off. Take the cooking tray out and put it onto a safe place. Keep children away from the hot oven during and after cooking, until it had cooled completely.

The indicator neon will glow. It may turn ON and OFF during use to show that the setting is being maintained.

WARNING!

Do not place dishes, tins and trays directly on the oven base as it becomes very hot and damage will occur.

To fit the top oven shelf

The shelf should be fitted with the straight rods uppermost on the frame and the forms towards the back of the oven. To remove a shelf slide the shelf towards you until the shelf stop is reached. Tilt shelf up at the front so that the stops clear the side supports. Lift shelf clear. To insert a shelf, reverse the above steps.

Hints and tips

- Arrange the shelves in the required positions before switching the oven on. Shelf positions are counted from the bottom upwards.
- There should always be at least 2.5 cm (1") between the top of the food and the element. This gives best cooking results and allows room for rise in yeast mixtures, Yorkshire puddings etc. When cooking cakes, pastry, scones bread etc., place the tins or baking trays centrally on the shelf.
- Ensure that food is placed centrally on the shelf and there is sufficient room around the

baking tray/dish to allow for maximum circulation.

- Stand dishes on a suitably sized baking tray on the shelf to prevent spillage onto the oven base and to help reduce cleaning.
- The material and finish of the baking tray and dishes used affect base browning. Enamelware, dark, heavy or non-stick utensils increase base browning. Shiny aluminium or polished steel trays reflect the heat away and give less base browning.
- Because of the smaller cooking space and lower temperatures, shorter cooking times are sometimes required. Be guided by the recommendations given in the cooking chart.
- Do not place baking trays directly on the oven base as it interferes with the oven air circulation and can lead to base burning; use the lower shelf position.
- For economy leave the door open for the shortest possible time, particularly when placing food into a pre-heated oven.

WARNING!

Do not place cookware and cooking pots with rough bases e.g. cast iron on the oven door as damage to the glass may occur.

The main oven

The fan oven is particularly suitable for cooking larger quantities of food. The advantages of fan oven cooking are:

Preheating

The fan oven quickly reaches its temperature, so it is not usually necessary to preheat the oven. Without preheating however, you may need to add an extra 5 – 10 minutes on the recommended cooking times. For recipes

needing high temperatures, e.g. bread, pastries, scones, soufflés etc., best results are achieved if the oven is preheated first. For best results when cooking frozen or cooked chilled ready meals always preheat the oven first.

Cooking temperatures

Fan oven cooking generally requires lower temperatures than conventional cooking. Follow the temperatures recommended in the cooking chart. As a guide reduce temperatures by about 20°C – 25°C for your own recipes, using a conventional oven.

Batch baking

The fan oven cooks evenly on both shelf levels, especially useful when batch baking.

To fit the main oven shelves

The shelf should be fitted with the straight rods uppermost on the frame and the forms towards the back of the oven. To remove a shelf slide the shelf towards you until the shelf stop is reached. Tilt shelf up at the front so that the stops clear the side supports. Lift shelf clear. To install a shelf, reverse the above steps.

Using the main oven

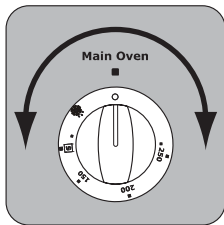

The switch for main oven allows you to select the oven functions. The symbols and their functions are briefly explained in the following lines. The detailed information for their usage will also be explained in the following pages.



Defrost function



Slow cook function

Hints and tips

- Arrange the shelves in the required positions before switching the oven on. Shelf positions are numbered from the bottom upwards.
- When cooking more than one dish in the fan oven, place dishes centrally on different shelves rather than cluster several dishes on one shelf, this will allow the heat to circulate freely for the best cooking results.
- When batch baking one type of food, e.g. Victoria sandwich cakes, those of similar size will be cooked in the same time.
- It is recommended that when baking larger quantities the shelf positions should be evenly spaced to suit the load being cooked. A slight increase in cooking time may be necessary.
- Do not place baking trays directly on the oven base as it interferes with the oven air circulation and can lead to base burning; use the lower shelf position.

! WARNING!

Do not place cookware and cooking pots with rough bases e.g. cast iron on the oven door as damage to the glass may occur.

*** Defrost**

This main oven function defrosts most foods faster than more conventional methods. It is particularly suitable for delicate frozen foods which are to be served cold e.g. cream filled gateaux, cakes covered with icings or frostings cheesecakes, biscuits, scones, etc. Turn the

main oven temperature control to the required setting.

Hints and tips

- Place the frozen food in a single layer where possible and turn it over half way through the defrosting process.
- The actual speed of defrosting is influenced by room temperature. On warm days defrosting will be faster than on cooler days.
- It is preferable to thaw fish, meat and poultry slowly in the fridge. However, this process can be accelerated by using the defrost function. Small or thin fish fillets, frozen peeled prawns, cubed or minced meat, liver, thin chops, steaks etc., can be thawed in 1 -2 hours.
- A 1 kg/2¼lb oven ready chicken will be thawed in approximately 5 hours. Remove the giblets as soon as possible during the thawing process.
- Joints of meat up to 2kg/4½lb in weight can be thawed using the defrost function.
- All joints of meat and poultry must be thawed thoroughly before cooking.
- Always cook thoroughly immediately after thawing.
- Do not leave food at room temperature once it is defrosted. Cook raw food immediately or store cooked food in the fridge, once it has cooled.
- Care must always be taken when handling foods in the home. Always follow the basic

rules of food hygiene to prevent bacterial growth and cross contamination when defrosting, preparing, cooking, cooling and freezing foods.

S Slow Cook Function

The slow cook setting gives a very low heat in the oven. It is particularly useful when you are cooking soups, stews and casseroles because the long slow cooking will make cheaper, tougher cuts of meat more tender. Some foods such as pastry and biscuits are not suitable for slow cooking because the temperature is too low. Cover all foods during cooking to prevent it from drying out. You can uncover food for the last half hour if it is normally served golden brown.

Using slow cook

You need to cook food at 180-190C for 30 minutes before you turn the oven down to the slow cook setting. This makes sure that the temperature of the food gets hot enough to start the food cooking.

The indicator neon will glow. It may turn on and off during use to show that the setting is being maintained.

Turn the oven control to the required setting. After 30 minutes turn the control to the slow cook setting **S**

Cooking tables

Oven cooking chart

The temperature and baking times are for guidance only, as these will depend on the consistency of the various ingredients and the number, type and size of baking tray or tins used. It may be necessary to increase or decrease the temperature to suit individual pref-

erence and requirements. For best results, moist recipes (for example pizza, fruit flans etc) should be baked on one level. To ensure optimal performance when cooking convenience foods, pizza or frozen and chilled ready meal, always preheat the oven first

FOOD	FAN OVEN COOKING TEMP °C	TOP OVEN		APPROX COOK TIME (h)
		POS	COOKING TEMP °C	
Biscuits	180 - 190	2	180 - 190	0:15 - 0:25
Bread	200 - 220	1	200 - 220	0:25 - 0:35
Bread rolls/buns	200 - 220	1	200 - 220	0:15 - 0:30
Small / Queen Cakes	160 - 170	1	170 - 180	0:20 - 0:30
Sponges	160 - 170	1	170 - 180	0:25 - 0:35
Victoria Sandwich	160 - 170	1	160 - 170	0:25 - 0:35
Madeira Cake	140 - 150	1	140 - 150	1:15 - 1:45
Rich Fruit Cake	140 - 150	1	140 - 150	2:15 - 2:45
Christmas Cake	130 - 140	1	130 - 140	3:00 - 4:45
Gingerbread	140 - 150	1	140 - 150	1:15 - 1:45
Meringues	90 - 100	1	90 - 100	2:30 - 3:15
Flapjack	170 - 180	1	170 - 180	0:30 - 0:35
Shortbread	130 - 140	1	140 - 150	0:45 - 1:00
Fruit Pies, Crumbles	190 - 200	1	190 - 200	0:45 - 1:00
Milk Puddings	130 - 140	1	140 - 150	1:30 - 2:15
Scones	210 - 220	1	220 - 230	0:08 - 0:18
Choux Pastry	190 - 200	2	190 - 290	0:35 - 0:45
Éclairs / Profiteroles	170 - 180	2	170 - 180	0:25 - 0:35
Flaky Pastry	210 - 220	2	210 - 220	0:25 - 0:45
Mince Pies	190 - 200	1	190 - 200	0:15 - 0:30

FOOD	FAN OVEN COOKING TEMP °C	TOP OVEN		APPROX COOK TIME (h)
		POS	COOKING TEMP °C	
Pasta Lasagne etc.	180 - 200	1	180 - 200	0:45 - 1:00
Meat Pies	190 - 210	1	190 - 210	0:40 - 0:50
Quiche, Tarts, Flans	180 - 210	1	180 - 210	0:35 - 0:45
Shepherd's Pie	190 - 200	1	190 - 200	0:30 - 0:55
Soufflés	170 - 180	1	170 - 180	0:20 - 0:40
Fish	170 - 190	1	170 - 190	0:20 - 0:40
Fish Pie	190 - 200	1	190 - 200	0:30 - 0:40
Beef Casserole	140 - 160	1	140 - 160	2:30 - 3:15
Lamb Casserole	140 - 160	1	140 - 160	2:30 - 3:15
Convenience Foods	Follow manufacturer's instruction			
Baked Potatoes	180 - 190	1	180 - 190	1:00 - 1:45
Roast Potatoes	180 - 190	1	180 - 190	1:00 - 1:45
Large Yorkshire Puddings	210 - 220	1	210 - 220	0:35 - 0:45
Individual Yorkshire Puddings	200 - 210	1	200 - 210	0:15 - 0:30

Roasting chart

Meat	Temperature	Cooking time
Beef/ Beef boned	160 - 180 °C	0:20 - 0:35 minutes per ½kg (1lb) and 0:20 - 0:35 minutes over.
Mutton/Lamb	160 - 180 °C	0:25 - 0:35 minutes per ½kg (1lb) and 0:25 - 0:35 minutes over.
Pork/Veal/Ham	160 - 180 °C	0:30 - 0:40 minutes per ½kg (1lb) and 0:30 - 0:40 minutes over.
Chicken	160 - 180 °C	0:20 - 0:25 minutes per ½kg (1lb) and 0:20 minutes over.

Meat	Temperature	Cooking time
Turkey/Goose	160 - 180 °C	0:20 - 0:25 minutes per ½kg (1lb) up to 3½kg (7lb) then 0:10 minutes per ½kg (1lb) over 3½kg (7lb).
Duck	160 - 180 °C	0:25 - 0:35 minutes per ½kg (1lb) and 0:25 - 0:30 minutes over.
Pheasant	160 - 180 °C	0:35 - 0:40 minutes per ½kg (1lb) and 0:35 - 0:40 minutes over.
Rabbit	160 - 180 °C	0:20 minutes per ½kg (1lb) and 0:20 minutes over.

INTERNAL TEMPERATURES –

Rare: 50-60°C; Medium: 60-70°C; Well done: 70-80°C

The roasting temperatures and times given in the chart should be adequate for most joints, but slight adjustments may be required to allow for personal requirements and the shape and

texture of the meat. However, lower temperatures and longer cooking times are recommended for less tender cuts, or larger joints.

Wrap joints in foil if preferred, for extra browning uncover for the last 0:20 – 0:30 min. cooking time.

Care and cleaning

Replacing the light bulb

Replace the bulb with a 25watt, 230 V (Type E14), 300 °C heat-resistant oven light bulb.

 **WARNING!**

Before cleaning always allow the appliance to cool down before switching off at the electricity supply.

- Cleaners that contain bleach should not be used as they may dull the surface finishes. Harsh abrasives and scourers should also be avoided. Multi-surface anti-bacterial cleaning products should not be used on the ceramic hob or on the surrounding trims.

Cleaning materials

- Before using any cleaning materials on your appliance, check that they are suitable and that their use is recommended by the manufacturer.

Cleaning the outside of the appliance

- Do not use abrasive cleaning materials e.g. abrasive cream cleaners, wire wool pads or scourers on painted or printed finishes as damage may occur. Regularly wipe over the control panel, control knobs, handles, doors and appliance sides using a soft cloth and hot soapy water. To prevent streaking, finish with a soft cloth.
- Stainless Steel cream cleaners are abrasive and should be avoided as they may dull the surface finish. Any spillage on the stainless steel finish must be wiped off immediately.

WARNING!

Do not attempt to remove any of the control knobs from the appliance as this may cause damage and is a safety hazard.

Cleaning the solid hob (ZKS5010)

Clean the hob after each use. To ensure the best results from your hob and to prolong its good looks regular cleaning and maintenance is essential. Cleaning and maintenance should only be carried out when the hob is cool.

Hob Surface

Hob surface should be cleaned with a lukewarm solution of water and a mild detergent, periodically it may be necessary to use a mild scouring agent. Dust, fat and liquids from food that has boiled over must be removed as soon as possible. Never use a scouring pad on the

hob surface and on no occasion use a sharp object.

Scratched or clipped surface cannot be repaired. In addition to the unsightly appearance this may lead to grooves appearing and eventually the enamel to crack.

Plates

To clean solid plates, firstly wipe off any excess spillage and if necessary clean the plates with a light abrasive pad than dry the plates thoroughly.

General information

- Drying may be facilitated by turning the plates onto the lowest setting for a short time until dry.
- Do not put any damp or wet items on the hotplates.
- Dry pots and pans with a cloth before placing them on the hotplates.

Cleaning the ceramic hob (ZKC5020S1/W1/X1-ZKC5030W1/S1/X1/ K1)

- Make sure the ceramic glass is cool before cleaning. It is important to clean the ceramic hob daily to prevent foodstuff being burnt on.
- Take care to avoid the hob trims when cleaning the ceramic glass as they may be damaged by the cleaning agents.

Daily cleaning

- Use a hob-cleaning product specifically designed for ceramic hobs daily. If foodstuff is not allowed to burn on it will be much easier to clean off.
- Apply a small amount of hob cleaner in the centre of each area to be cleaned.
- Dampen a clean paper towel or a plastic pad designed for non-stick saucepans and rub vigorously until all marks are removed. This may take a few minutes.
- Wipe off residues of cleaner with another damp paper towel and polish dry with a soft cloth.
- If hob cleaner is unavailable, one or more of the cleaning agents below may be used temporarily:
 - Cream Cleaner
 - Baking Soda

To remove more stubborn marks

- Cream cleaner may be used to clean off more stubborn stains or to remove discolouration.
- It may be necessary to rub the marks hard for several minutes.
- Use a plastic pad designed for non-stick saucepans with cream cleaner for removal of more stubborn stains.

To remove burnt on foodstuff

- We strongly recommend the use of a Ceramic Hob Scraper (incorporating a single edge razor blade) to remove spillage on the hob, in particular sugar solutions, which if not removed can cause permanent damage.
- Make sure the ceramic glass is cool.

- Use a ceramic hob scraper with care at an angle of 30° to remove as much foodstuff as possible.
- Use hob cleaner or cream cleaner to finish off as directed above.

To remove discolourations or white and silver marks

- These marks sometimes give the impression of being in or underneath the hob glass. They can almost always be removed provided they have not become excessively burnt on. Follow the instructions above under 'To remove more stubborn marks'.
- If this is unsuccessful, make up a paste of one part water to three parts Cream of Tartar and leave on the discoloured areas overnight. The marks should be easily removable the next day provided they have not been excessively burnt on. The paste should be thoroughly washed off afterwards.

To reduce marking of the hob

- Make sure the bottom of the saucepan and the cooking area is clean and dry before cooking begins.
- Ensure saucepans are large enough to accommodate food to avoid boil-over.
- If possible, wipe up spills and splatters as they occur, but take care to avoid steam burns.
- Avoid using a dishcloth or sponge to clean the hob. These may leave a layer of soiled detergent on the hob surface, which will burn and discolour the next time the hob is used.

Avoid the use of:

- Household detergents and bleaches.

- Impregnated plastic or nylon pads that are not described as suitable for non-stick saucepans.
- Abrasive cleaning pads, scourers and steel wool pads.
- Chemical oven cleaners, e.g. aerosols and oven pads.
- Rust stain, bath and sink stain removers.
- Any of the above products may cause damage to the hob.
- It is dangerous to mix different cleaning products. The chemicals in them may react with each other with hazardous results.
- Sugar solutions must be removed from the hob before the syrup has set otherwise damage to the hob surface will occur.
- Avoid placing plastic items, foil or dishes on the hot surface as this will cause damage to the hob.

Cleaning the grill/oven furniture

- All removable parts, except the grill pan handle can be washed in the dishwasher.
- The grill pan, grill pan grid and oven shelves may be cleaned using a soap impregnated steel wool pad. Soaking first in hot soapy water will make cleaning easier.

Cleaning inside the grill and oven compartments

- The vitreous enamel main oven and grill compartment can be cleaned using normal oven cleaners with care. Ensure that the manufacturers instructions are followed and that all parts are well rinsed afterwards.

IMPORTANT!

Aerosol cleaners must not come into contact with elements, the door seal, or any painted finishes as this may cause damage.

Cleaning the door(s)

WARNING!

To prevent damaging or weakening the door glass panels avoid the use of the following:

- Household detergents and bleaches.
- Soap impregnated pads unsuitable for non-stick saucepans.
- Abrasive cleaning pads, scorers and steel wool pads.
- Chemical oven pads or aerosols.
- Rust removers.
- Bath/Sink stain removers.

Cleaning between the outer and inner door glass

WARNING!

Rough handling, especially around the edges of the front panel, can cause the glass to break.

To clean the glass door panels

Clean the glass door panels using hot soapy water, hob cleaner may also be used. Do not use hob cleaner on the stainless steel or painted surfaces. Ensure that all parts are well rinsed and thoroughly dried before attempting to replace the glass.

! WARNING!

If the door glass becomes chipped or has deep scratches the glass will be weakened and must be replaced to prevent the possibility of the panel shattering. Please contact your local service force centre who will be pleased to advise further.

! WARNING!

Do not attempt to use the oven without the glass being in place.

Removal of inner Glasses (if applicable)

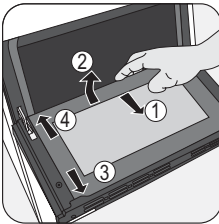

Before cleaning the oven door glasses, you must pull out the inner glass as shown:

- Push the glass towards direction 1 and release from the location bracket .
- Pull out the glass towards direction 2.

After cleaning:

- Push the glass towards and under the cover (towards to direction 3).
- Place the glass under the location bracket (towards to direction 4).

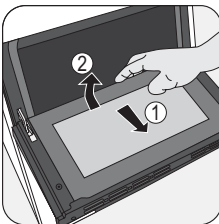

If the oven door is the triple glass oven door, the third glass can also be pulled out the same way as second glass.

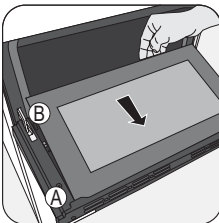

After Cleaning:

- Push the glass towards under the location bracket "A".
- Place the glass under location bracket "B".

What to do if...

Please carry out the following checks on your appliance before calling a Service Engineer. It may be that the problem is a simple one which you can solve yourself without the expense of a service call.

In-guarantee customers should make sure that the checks have been made as the en-

gineer will make a charge if the fault is not a mechanical or electrical breakdown.

Please note that proof of purchase is required for in-guarantee service calls.

Problem	Possible solution
The grill, ovens and timer do not work.	<ul style="list-style-type: none">• Check that the appliance has been wired in to the appliance supply and is switched on at the wall.• Check that the main appliance fuse is working.• If you have checked the above: Allow the appliance to cool for a couple of hours. The appliance should now be working normally.
The grill and top oven work but the main oven does not.	<ul style="list-style-type: none">• Check that the time of day has been set on the clock.
The timer does not work.	<ul style="list-style-type: none">• Check that the instructions for the operation of the timer are being closely followed.
The oven is not cooking evenly.	<ul style="list-style-type: none">• Check that the appliance is correctly installed and is level.• Check that the recommended temperatures and shelf positions are being used.
The indicator neons are not working correctly.	<ul style="list-style-type: none">• Check that you have selected only the function you require. Ensure all other controls are in the off position.
The oven fan is noisy.	<ul style="list-style-type: none">• Check that the oven is level.• Check that the shelves and bakeware are not vibrating in contact with the oven back panel.
The oven temperature is too high or too low.	<ul style="list-style-type: none">• Check that the recommended temperatures and shelf positions are being used. Be prepared to adjust the temperature up or down to achieve the results you want.

Installation

Installation instructions

WARNING!

This appliance must be earthed

- If your appliance has been damaged in transit, contact your supplier immediately. Do not attempt to install it.
- Your appliance left the factory fully packaged to protect it from damage. If it is delivered without packaging and damage has occurred, the manufacturer cannot accept responsibility. Contact your supplier for advice.
- Once the packaging has been removed the appliance should only be moved by hand. Do not use a sack barrow or any other aid to lift the appliance as damage may occur. Do not carry the appliances at the doorhandle.
- To move the appliance, open the oven door and lift the appliance by holding inside the top of the compartment.
- This is a type X appliance, which means it is freestanding and can be fitted with cabinets on one or both sides.
- Sidewalls, which are above hob level, should be protected by heat resistant non-combustible material and must not be nearer than 40mm to the hob side.
- A nominal air gap of 2mm at either side of the appliance is required to enable the appliance to be moved into position.
- Always ensure an air gap is maintained at hotplate level. Tiles or other forms of deep wall covering should not obscure this gap.

- Overhanging surfaces or a cooker hood should be a minimum of 685mm above the hob.
- It is important to ensure that the appliance is level after installation. Levelling feet are fitted to the appliance to accommodate uneven floors.

Adjustment of levelling feet

The cooker stands on 4 levelling feet. It is required to confirm the appliance is correctly levelled before operating it. This adjustment can be made by turning the levelling feet clockwise or anti-clockwise, if required. It is possible to raise the product up to maximum of 35 mm via the levelling feet. If it becomes necessary to move the appliance after the levelling feet have been adjusted, it is advisable to lift and not drag. The levelling feet can be adjusted by hand or by using a metal coin of the correct size.

Connecting to the electricity supply

WARNING!

This appliance must be earthed. Do not earth this appliance to gas supply piping. Connect to 230 - 240V AC supply only.

- Connection to the electricity supply must be carried out by a qualified electrician/competent person.

- The electrical connection should be made using a double pole isolating switch (cooker socket) with at least 3mm contact separation in all poles. The cable must have conductors of sufficiently high cross-sectional area to prevent overheating and deterioration.
- We recommend you use a new length of 6mm² twin core earthed cable to ensure your safety.
- The cable should be routed away from potentially hot areas.

Connection diagram is given as below:

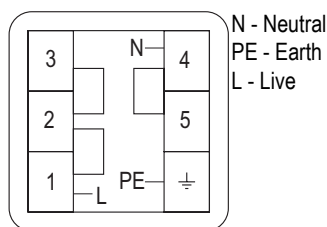

Technical Data

	CERAMIC	SOLID
Overall height of appliance to top of hob	895 mm	898 mm
Maximum width of appliance	495 mm	495 mm
Maximum depth of appliance	656 mm	656 mm
Weight of the appliance	41,1kg	43,9kg

This appliance complies with: European Council Directive 73/23/EEC, EMC Directive 89/336/

EEC, CE Marking Directive 93/68/EEC, Energy Label Directive 2002/40/EC.

Technical Specifications for Top and Main Oven

Top Oven of 50x60 cooker	Rating
Top Heating Element	500 W
Bottom Heating Element	600 W
Grill Heating Element	1400 W

Main Oven of 50x60 cooker	Rating
Ring Heating Element	2000 W

Ceramic Hob	Rating
145 mm	1200 W

Ceramic Hob	Rating
180 mm	1800 W
180 mm	1700 W
180 mm	1800 W

Solid Hob	Rating
145 mm hotplate	1000 W
145 mm rapid hotplate	1000 W
180 mm hotplate	1500 W
180 mm rapid hotplate	2000 W

Environmental Information

The symbol  on the product or on its packaging indicates that this product may not be treated as household waste. Instead it should be taken to the appropriate collection point for the recycling of electrical and electronic equipment. By ensuring this product is disposed of correctly, you will help prevent potential negative consequences for the environment and human health, which could otherwise be caused by inappropriate waste

handling of this product. For more detailed information about recycling of this product, please contact your local council, your household waste disposal service or the shop where you purchased the product.

After installation please dispose of the packaging with due regard for safety and the environment. Your local authority can arrange this.

Guarantee/Customer Service

GREAT BRITAIN & IRELAND

Standard guarantee conditions

We, Electrolux, undertake that if within 12 months of the date of the purchase this Electrolux appliance or any part thereof is proved to be defective by reason only of faulty workmanship or materials, we will, at our option repair or

replace the same FREE OF CHARGE for labour, materials or carriage on condition that:

- The appliance has been correctly installed and used only on the electricity supply stated on the rating plate.
- The appliance has been used for normal domestic purposes only, and in accordance with the manufacturer's instructions.

- The appliance has not been serviced, maintained, repaired, taken apart or tampered with by any person not authorised by us.
- Electrolux Service Force Centre must undertake all service work under this guarantee
- Any appliance or defective part replaced shall become the Company's property.
- This guarantee is in addition to your statutory and other legal rights.

Exclusions

- Damage or calls resulting from transportation, improper use or neglect, the replacement of any light bulbs or removable parts of glass or plastic.
- Costs incurred for calls to put right an appliance which is improperly installed or calls to appliances outside the United Kingdom.
- Appliances found to be in use within a commercial environment, plus those which are subject to rental agreements.
- Products of Electrolux manufacturer that are not marketed by Electrolux

Service and Spare Parts

In the event of your appliance requiring service, or if you wish to purchase spare parts, please contact your local Service Force Centre by telephoning

0870 5 929 929

Your telephone call will be automatically routed to the Service Force Centre covering your post-code area.

For the address of your local Service Force Centre and further information about Service Force, please visit the website at www.serviceforce.co.uk

Before calling out an engineer, please ensure you have read the details under the heading "What to do if..."

When you contact the Service Force Centre you will need to give the following details:

1. Your name, address and postcode.
2. Your telephone number.
3. Clear concise details of the fault.
4. The model and Serial number of the appliance (found on the rating plate).
5. The purchase date.

Please note a valid purchase receipt or guarantee documentation is required for in guarantee service calls.

Customer Care

For general enquiries concerning your Electrolux appliance, or for further information on Electrolux products please contact our Customer Care Department by letter or telephone at the address below or visit our website at www.electrolux.co.uk

Customer Care Department Electrolux Major Appliances Addington Way Luton Bedfordshire, LU4 9QQ

	Tel:
Electrolux	08705 950 950 (*)
AEG-Electrolux	08705 350 350 (*)
Zanussi-Electrolux	08705 727 727 (*)

(*) Calls may be recorded for training purposes

For Customer Service in The Republic of Ireland please contact us at the address below:

Electrolux Group (Irl) Ltd Long Mile Road,
Dublin 12, Republic of Ireland Tel: +353 (0)1
4090751 Email: service.eid@electrolux.ie

European Guarantee

This appliance is guaranteed by Electrolux in each of the countries listed at the back of this user manual, for the period specified in the appliance guarantee or otherwise by law. If you move from one of these countries to another of the countries listed, the appliance guarantee will move with you subject to the following qualifications:-



- The appliance guarantee starts from the date you first purchased the appliance which will be evidenced by production of a valid purchase document issued by the seller of the appliance.
- The appliance guarantee is for the same period and to the same extent for labour and parts as exists in your new country of resi-



dence for this particular model or range of appliances.

- The appliance guarantee is personal to the original purchaser of the appliance and cannot be transferred to another user.
- The appliance is installed and used in accordance with instructions issued by Electrolux and is only used within the home, i.e. is not used for commercial purposes.
- The appliance is installed in accordance with all relevant regulations in force within your new country of residence.

The provisions of this European Guarantee do not affect any of the rights granted to you by law.

www.electrolux.com

		
Albania	+35 5 4 261 450	Rr. Pjeter Bogdani Nr. 7 Tirane
Belgique/België/Belgien	+32 2 363 04 44	Bergensesteenweg 719, 1502 Lembeek
Česká republika	+420 2 61 12 61 12	Budějovická 3, Praha 4, 140 21
Danmark	+45 70 11 74 00	Sjællandsgade 2, 7000 Fredericia
Deutschland	+49 180 32 26 622	Muggenhofer Str. 135, 90429 Nürnberg
Eesti	+37 2 66 50 030	Pärnu mnt. 153, 11624 Tallinn

		
España	+34 902 11 63 88	Carretera M-300, Km. 29,900 Alcalá de Henares Madrid
France	www.electrolux.fr	
Great Britain	+44 8705 929 929	Addington Way, Luton, Bedfordshire LU4 9QQ
Hellas	+30 23 10 56 19 70	4, Limnou Str., 54627 Thessaloniki
Hrvatska	+385 1 63 23 338	Slavonska avenija 3, 10000 Zagreb
Ireland	+353 1 40 90 753	Long Mile Road Dublin 12
Italia	+39 (0) 434 558500	C.so Lino Zanussi, 26 - 33080 Porcia (PN)
Latvija	+37 17 84 59 34	Kr. Barona iela 130/2, LV-1012, Riga
Lietuva	+370 5 278 06 03	Ozo 10a, LT-08200 Vilnius
Luxembourg	+352 42 431 301	Rue de Bitbourg, 7, L-1273 Hamm
Magyarország	+36 1 252 1773	H-1142 Budapest XIV, Erzsébet királyné útja 87
Nederland	+31 17 24 68 300	Vennootsweg 1, 2404 CG - Alphen aan den Rijn
Norge	+47 81 5 30 222	Risløkkvn. 2 , 0508 Oslo
Österreich	+43 18 66 400	Herziggasse 9, 1230 Wien
Polska	+48 22 43 47 300	ul. Kolejowa 5/7, Warszawa
Portugal	+35 12 14 40 39 39	Quinta da Fonte - Edifício Gonçalves Zarco - Q 35 -2774-518 Paço de Arcos
Romania	+40 21 451 20 30	Str. Garii Progresului 2, S4, 040671 RO
Schweiz - Suisse - Svizzera	+41 62 88 99 111	Industriestrasse 10, CH-5506 Mägenwil
Slovenija	+38 61 24 25 731	Gerbičeva ulica 98, 1000 Ljubljana
Slovensko	+421 2 43 33 43 22	Electrolux Slovakia s.r.o., Electrolux Domáce spotrebiče SK, Seberíniho 1, 821 03 Bratislava
Suomi	www.electrolux.fi	

		
Sverige	+46 (0)771 76 76 76	Electrolux Service, S:t Göransgatan 143, S-105 45 Stockholm
Türkiye	+90 21 22 93 10 25	Tarlabası caddesi no : 35 Taksim İstanbul
Россия	+7 495 937 7837	129090 Москва, Олимпийский проспект, 16, БЦ "Олимпик"
Україна	+380 44 586 20 60	04074 Київ, вул.Автозаводська, 2а, БЦ "Алкон"

ZANUSSI

 Electrolux

www.electrolux.com

www.zanussi-electrolux.co.uk