

Users Guide & Installation Handbook



Stoves Range
Electric Induction UK

Part No 082759604 Date 04/12/2014

CONTENTS & INTRODUCTION

CONTENTS

- SAFETY
- USING THE PRODUCT
- CLEANING
- INSTALLATION INSTRUCTIONS
- TECHNICAL DATA
- CUSTOMER CARE

INTRODUCTION

Thank you for buying this British-built appliance from us.

This guide book is designed to help you through each step of owning your new cooker, from installation to use. Please read it carefully before you start using your product, as we have endeavored to answer as many questions as possible, and provide you with as much support as we can.

If, however, you should find something missing, or not covered, please contact our Customer Care team. Their number is located on the back page of this book.

For customers outside the UK and Northern Ireland, please contact your local supplier.

When you dial this number you will hear a recorded message and be given a number of options. This indicates that your call has been accepted and is being held in a queue. Calls are answered in strict rotation as our Customer care representatives become available.

Alternatively, general information, spares and service information is available from our website. The address is located on the back page of this book.

WARRANTY

Your new appliance comes with our 12 month guarantee, protecting you against electrical and mechanical breakdown. To register your appliance please call **0844 481 0182**, complete the registration form included or register online at the web address located on the back page of this book.

For full terms & conditions of the manufacturer's guarantee, refer to the website on the back of this book.

In addition, you may wish to purchase an extended warranty. A leaflet explaining how to do this is included with your appliance.

European Directives

As a producer and a supplier of cooking appliances we are committed to the protection of the environment and are in the compliance with the WEEE directive. All our electric products are labelled accordingly with the crossed out wheeled bin symbol. This indicates, for disposal purposes at end of life, that these products must be taken to a recognised collection points, such as local authority sites/local recycling centres

This appliance Complies with European Community Directives (CE) for household and similar electrical appliances and Gas appliances where applicable.

This appliance conforms to European Directive 2009/125/EC regarding Eco design requirements for energy-related products

Our policy is one of constant development and improvement, therefore we cannot guarantee the strict accuracy of all of our illustrations and specifications - changes may have been made subsequent to publishing.

SAFETY

BEFORE USING THE PRODUCT

Make sure that you have removed all packaging and wrapping. Some of the items inside this appliance may have additional wrapping.

It is advised that you turn the ovens and/or grill on for a short while. This will burn off any residues left from manufacturing. There may be a smell which accompanies this process - but this is nothing to worry about and is harmless.

It is recommended that you wash the oven shelves, baking tray, grill pan and grill pan trivet before their first use in hot soapy water. This will remove the protective oil coating.

WARNING! - The appliance and its accessible parts become hot during use. Care should be taken to avoid touching heating elements. Children less than 8 years of age shall be kept away unless continuously supervised. This appliance can be used by children aged from 8 years and above and persons with reduced physical sensory or mental capabilities or lack of experience and knowledge if they have

been given supervision or instruction concerning the use of the appliance in a safe way and understand the hazards involved. Children shall not play with the appliance. Cleaning and user maintenance shall not be made by children without supervision.

WARNING! -

Unattended cooking on a hob with fat or oil can be dangerous and may result in fire.

NEVER try to extinguish a fire with water, but switch off the appliance and then cover the flame with a lid or damp cloth.

WARNING! - Danger of fire: Do not store items on the cooking surfaces.

WARNING! - Servicing should be carried out only by authorised personnel.

SAFETY

WARNING! - The appliance must never be disconnected from the mains supply during use, as this will seriously affect the safety and performance, particularly in relation to surface temperatures becoming hot and gas operated parts not working efficiently. The cooling fan (if fitted) is designed to run on after the control knob has been switched off.

WARNING! -

Do not spray aerosols in the vicinity of this appliance while it is in operation.

WARNING! - Do not store or use flammable liquids or items in the vicinity of this appliance.

WARNING! -

Do not modify this appliance.

WARNING! - Do not use harsh abrasive cleaners or sharp metal scrapers to clean the oven door glass since they can scratch the surface, which may result in shattering of the glass.

WARNING! - Do not operate the appliance without the glass panel correctly fitted.

WARNING! - There is a risk of electric shock, so always make sure you have turned off and unplugged your appliance before starting. Always allow the product to cool down before you change a bulb.

WARNING! - Accessible parts may become hot when the grill is in use. children should be kept

SAFETY

away.

WARNING! - Never place food, or dishes on the base of the main oven, the element is here and it will cause over heating.

WARNING! - Do not modify the outer panels of this appliance in any way.

WARNING! - This appliance must be earthed.

WARNING! - The top element gets extremely hot when in use, so take care to avoid touching it.

ELECTRIC INDUCTION HOB

WARNING:-

Unattended cooking on a hob can be dangerous and may result in fire. NEVER try to extinguish a fire with water, but switch off the appliance and then cover flame

e.g. with a lid or a damp cloth.

Danger of fire: do not store items on the cooking surface.

If the surface is cracked, broken or shattered, switch off the appliance to avoid the possibility of electric shock and call for a service engineer's visit.

Metallic objects such as knives, forks, spoons and lids should not be placed on the hob surface since they can get hot.

Ensure you switch off the appropriate cook zone individually or by the central on/off key when you have finished cooking, do not rely upon the automatic pan detection system as your means of switching "off" the appliance. This

SAFETY

induction hob complies with the applicable EMC and EMF standards. Therefore it should not interfere with other electronic units. Persons fitted with a pacemaker or any other electrical implant should clarify with their doctor or the producer of the implant, whether there implant is adequate and fail-safe, the pacemaker must be designed in compliance with the appropriate regulations.

Caution: This appliance is for cooking purposes only. It must not be used for other purposes, for example room heating.

OVEN/GRILL

Do

- Always take care when removing food from the oven as the area around the cavity may be hot.
- Always use oven gloves when handling any utensils that have been in

the oven as they will be hot.

- Always make sure that the oven shelves are resting in the correct position between two runners. Do not place the oven shelves on top of the highest runner, as this is not stable and can lead to spillage or injury.

Always use the Minute Minder (if fitted) if you are leaving the oven unattended - this reduces the risk of food burning.

Do Not

- Never place items on the door while it is open.
- Never wrap foil around the oven shelves or allow foil to block the flue.
- Never drape tea towels near the oven while it is on; this will cause a fire hazard.
- Never pull heavy items, such as turkeys or large joints of meat, out from the oven on the shelf, as they may overbalance and fall.
- Never use this appliance to heat anything other than food items and do not use it for heating the room.
- Do not spray aerosols in the vicinity of this appliance while it is in operation.
- Do not store or use flammable liquids or items in the vicinity of this appliance.
- Do not modify this appliance.

GENERAL

Do

- Always ensure that pan bases are dry and flat before using them on the hob.
- Always position pans over the centre of the heat zone, and turn

SAFETY

the handles to a safe position so they cannot be knocked or grabbed. Always use pans which are no smaller than 100mm (4"), or no larger than 250mm (10").

- Always match the size of pan to the size heat zone – do not use large pans on small zones or vice versa.
- Always lift pans onto and off the hob, rather than sliding them across the surface, to avoid marks and scratches.

Do Not

- If the appliance has a glass hobtop, never drag pans across the ceramic surface as this will lead to scratches and damage.
- Never use double pans, rim-based pans, old or misshapen pans, or any pan that is not stable on a flat surface.
- Never leave cooking fat, or oil, unattended.
- Never use commercial simmering aids, or heat diffusers, as they create excessive heat and can damage the surface of the hob.
- Never use the hob for any other purpose than cooking food.
- Never leave plastic cooking utensils close or on top of the hob as these can melt due to the warm hob.
- Never leave any cook zone on without a pan covering it. This causes a fire hazard.
- Never leave pans overhanging the edge of the hob. The surface of the hob is smooth. If pans are knocked they may move on the hob top.
- Never leave pans on the hob when you're not around - take them off the cook zone

FIRE SAFETY ADVICE

Most kitchen fires occur when people are distracted or leave things unattended, so remember:

If you're called away from the cooker - by the phone or someone at the door, either take pans off the heat, or switch off your hob.

Don't let yourself be distracted while cooking.

If you do have a fire in the kitchen, don't take any risks - get everyone out of your home and call the Fire Brigade.

If a pan catches fire:

- Do not move it - it is likely to be extremely hot.
- Turn off the heat if it's safe to do so - but never lean over a pan to reach the controls.
- If you have a fire blanket, put it over the pan.
- If you have put the fire out, leave the pan to cool completely.

Deep-fat frying presents more dangers in your kitchen.

- Never fill a chip pan (or other deep-fat fryer) more than one-third full of oil
- Do not use a fire extinguisher on a pan of oil - the force of the extinguisher can spread the fire and create a fireball.

If you have an electrical fire in the kitchen:

- Pull the plug out, or switch off the power at the fuse box - this may be enough to stop the fire immediately
- Smother the fire with a fire blanket, or use a dry powder or carbon dioxide extinguisher
- Remember: never use water on an electrical or cooking oil fire.

USING THE HOB

USING THE HOTPLATE

- Commercial simmering aids should not be used as they create excessive temperatures that can damage the surface and may cause a hazard.
- Do not place aluminium foil or plastic utensils on the ceramic glass, as they may melt and damage the surface.
- Do not use the ceramic glass hotplate surface for storage.
- When cooking with fat or oil, never leave unattended.
- Turn pan handles to a safe position, so they are out of reach of children, not overhanging the appliance, and cannot be caught accidentally.
- Position pans over the centre of the hotplate elements.
- Do not use the hob as a chopping board or a storage area, as this increases the likelihood of it being damaged - e.g.; plastic utensils placed on a warm hob may melt onto it, and damage the ceramic glass surface.
- Be careful when cooking foods in salted water, or foods containing large amounts of sugar, syrup or jam - if they are spilled onto hot areas of the hob they may damage it.
- Lift pans onto and off the surface, rather than sliding them across the surface, to avoid marks and scratches.
- If you use a wet paper towel to remove spills from a warm heating area of the hob, be careful to avoid steam burns.
- Do not use abrasive powder cleaners, metal wire wool pads, impregnated plastic pads, detergents, bleaches, bath stain removers, or chemical oven cleaners; all these types of products will damage the ceramic glass.

The functions of the hob comply with the applicable standards on electromagnetic interference

Your induction cooking hob thus complies fully with the statutory requirements (Directive 2004/108/EC). It is designed to not interfere with the functioning of other electrical equipment as long as these also comply with the same regulations.











Your induction hob generates magnetic fields in its immediate vicinity.

So that there is no interference between your cooking hob and a pacemaker, the pacemaker must be designed in compliance with the appropriate regulations.

In this respect we can only guarantee the compliance of our own product. You can ask the manufacturer or your doctor about the compliance or any incompatibilities of your pacemaker.

Once you have powered on the induction hob, you have 10 seconds to set the power or use the timer, before the induction hob is automatically switched off.

USING THE HOB

Feature	Symbol	Description
Eco power		Induction Power is the most energy efficient means of cooking food, provides fast heat up and boiling times
Slide Control		Slide your finger along the graphic or simply touch the graphic at the power level you require.
Digital display		Secret till "lit" hob display
No. of power levels	13	Precise and repeatable control settings
Special Functions		Three preset temperature controls set at 42°C, 70°C, and 94°C. Ideal for Melting chocolate, Warming and Rapid Simmer respectively
Central Power On/Off		Power On / Off for the Induction hob
Power Boost		Temporarily boost the power to a cook zone by a massive 60%
Pause/un-pause		This button pauses cooking with one touch. (cuts power)
Minute Minder		To a maximum time of 9 hours 99 minutes, you can time anything
Auto Time Switch's Off all 5 zones	Yes	All five zones can be simultaneously timed to turn off automatically
Key Lock		To prevent accidentally changing settings, press the key graphic to lock the controls
Pan Detection		Lets you know if the correct pans are being used and helps to save energy. When a pan is lifted off the zone, the power is automatically cut.
Overheat Pan Detection	Yes	Helps prevent cookware from overheating providing an additional level of safety not available on other types of hobs
Child lock	Yes	Prevents unintentional operation of the hob
Residual Heat Indications		Warns you against hot surfaces but also indicates that the residual heat which can be used as a temporary warm zone
Holiday Shutdown	Yes	No operation is required - the hob will turn its self off if left

USING THE HOB

About the induction hob

The induction hob provides the most energy efficient hob technology available.

The induction system provides superior heat up and cool down times for pans - you get fast, precise, repeatable power control.

As induction only heats up the pan, there is no lost heat from the cooking process, which in turn, limits the heat generated in the kitchen.

Auto Power Tuning

Induction hobs have a unique power tuning system that automatically tunes the power to the size of the pan base this ensures energy isn't wasted.

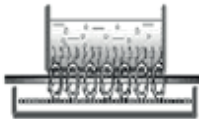

Small Pan



Large Pan

Touch Controls

The touch controls for your induction have been designed to provide you with finger touch control of your hob, providing accurate and repeatable power settings for cooking and an easy clean surface that can be easily wiped over.

Each cook zone displays its individual power setting.

Using the Touch Controls

To select a cook zone or the timer, simply touch the graphic slider, using the flat of your finger, not the tip. The controls respond to touch, so you don't need to apply any pressure.

Once you have powered on the induction hob, you have 10 seconds to set the power or use the timer.

If the red displays disappear, simply press the power button again.

Always ensure the control area is clean, dry and free from any objects (e.g. utensils, tea towels and cloths). Spillages and water may make the controls difficult to operate.

Basic Hob Function

Turning on the hob.

- Use the on/off button.

Activating a cook zone.

Select the slider and operate by sliding your finger across the graphic or touching the graphic at the desired power level (0-9).

Modifying the power setting whilst cooking

Turning off individual cooking zones.

1) Decrease the power setting until the display shows **0**. If the cook zone surface is hot to touch, **H** will replace **0** in the display.

USING THE HOB

Induction controls

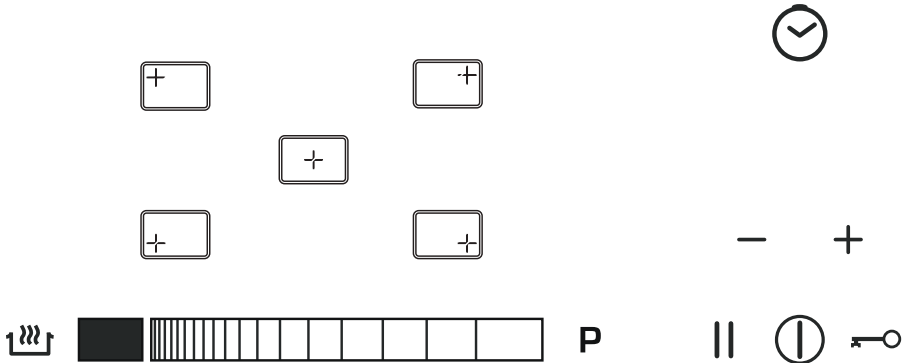

Power Boost **P**

This feature, temporarily boost the power to a cook zone by 60%.

The power boost is a function that can be used to temporarily boost the normal maximum power for a cook zone by borrowing the available power from a "paired zone".

All the cook zones have this function

The Power Boost is activated by sliding or touching the P

Note The Power Boost function will only operate for a limited time and is also under thermal control. This means the power boost will deactivate automatically if the product is hot, to protect the internal electronic components of the hob and to prevent the cookware from overheating.

Smallest recommended pan diameter

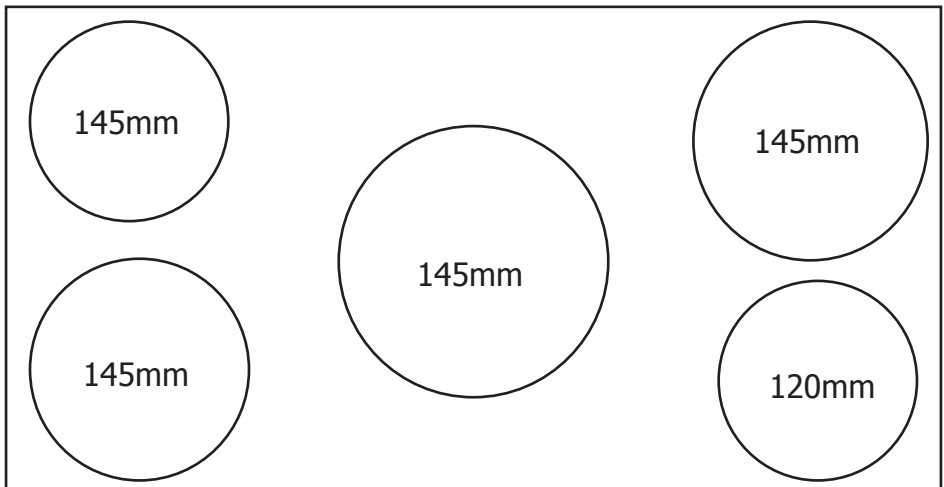

USING THE HOB

Special Function Key



Touch once for Function 1
42 °C - Ideal for melting or
sauces



Touch twice for Function 2
70 °C - Ideal for keeping warm



Touch three times for Function 3
94 °C - Ideal for a Rapid Simmering.



Pan detection

When a zone has been activated but no pan has been placed on the cook zone, the zone will recognise that there is no pan in position. It also means the hob only uses power when a suitable pan is placed on the zone. This reduces the energy used during the cooking process, i.e. when you take your pan off the zone the hob automatically reduces the power, and only switches back on when you replace the pan.

Note If the  symbol does not disappear when a pan is placed on the zone it indicates that the pan is not suitable for induction cooking.

SPECIAL HOB FUNCTIONS

On/Off switch

The central on/off switch enables all of the cooking zones to be switched on/off simultaneously at a touch of a button, so when you have finished cooking or are called away from the kitchen for any reason you can be safe in the knowledge that everything is under control and safe.

To Operate

1.) Select the on/off key. The key needs to be pressed for at least 1 second to activate, this is to ensure that the hob cannot be activated unintentionally.

Note:

All other keys only need to be pressed for 0.3 seconds to be activated/deactivated.

Note:

“H” will appear on any cook zone display that is still hot to touch.

Using the Timer



The timer has up to 7 timers. 6 timers to be assigned to the cooking zones and one independent timer called egg-timer.

The displays show the remaining time until the alarm is activated.

All timers work as count down timers. The operation range is between 1 min to 2h 59min. For times less than 59mins, the display is exact to the second.

Before activating a timer the control has to be switched on. Switching the control off deactivates cooking zone related timers. The egg timer stays active after switching the control off.

A symbol next to the zone will be lit when a timer is set to that zone

Activating Cooking Zone Timer

To activate the timer, press both the plus (+) and minus (-) keys together.

A timer can be activated for each active cooking zone. After selecting the timer the cooking zone related luminous symbol is fully lit and the timer display shows 0.00. For the following 10 sec it is now possible to assign a timer value to the active cooking zone. After 10sec without input, the timer function is deactivated and the

USING THE HOB

display is switched off again. Using the timer selection key again (as long as no value was set) the next active cooking zone can be selected.

Setting a timer value

- By pressing the timer keys, a timer value can be set. If the timer-plus-key is pressed first the display starts with 1min and can be increased in 1min steps. If the timer-minus-key is pressed first the timer starts with 15 min and can be decreased in 1 min steps.
- Pressing the key permanently speeds up the timer adjustment. The speed will also increase while the key is held. (the time between two time steps reduces).
- If a timer has expired the timer alarm is activated and the assigned cooking zone is immediately switched off.
- The cooking zone display shows 0 or H.

If no user input stops the alarm signal it will be on for maximum 2 minutes.

The alarm can be deactivated by switching off the control using the main switch or by pressing the two timer keys or it will be deactivated automatically after 2 minutes.



Switching off a timer or changing the time setting

The timer value can be modified at any time by selecting the timer and then by pressing the (+ or -) timer key.

To stop an active timer the value can be set to 0. Pressing Plus and Minus simultaneously for 2 seconds also resets the timer value to 0.00.

Minute Minder

The minute minder buzzes when the time set has expired. It does not switch off any zone.

To operate:

- 1) Turn on the hob, using the on/off key.
- 2) Select the timer by pressing the + and - keys together (do not activate any cook zone).
- 3) Set the right hand digit up to 9 minutes (Single Minutes Units) and wait a couple of seconds.
- 4) The display will now indicate for you to set the left hand digit, up to 90 minutes (10 Minute Units).
- 5) The timer is now set and begins counting down. (No zone indicator light should be set).
- 6) You can now use the hob as normal.

When the time is up.

- 1) The corresponding indicator in the timer display will flash, the timer will beep.
- 2) Touch any control to stop the beeping.

Warning!

Never leave the hob unattended when in use, even when you have set the timer to turn off the cook zone.

Additional timer information

To modify or cancel a timer setting follow steps 1) to 5) above.

To set the timer for additional zones follow steps 1) to 5) above.

If multiple zones have been set for timed operation, the timer display will always display the time for the cook zone with the shortest time remaining.

To check the timer setting for a different cook zone, simply select the required cook zone, the remaining time will briefly appear in the timer display.

USING THE HOB

Pause key

Warning!

Don't leave pans on the hob when you're not around - take them off the heat if you have to leave the kitchen (even if you think it will only be for a moment, while you answer the door or phone) or you can use the Pause Key.

The Pause key is ideal for unexpected interruptions when cooking. With this button you can pause all cooking settings (Cuts power) with one touch.

To Operate

1) Press the pause key.

Note:-

All cook zones functions will pause (no power) and will be displayed for each cook zone.

2) To restart, press the pause button and then within 10sec use the cooking zone slider left to the timer (slide from low to higher levels).

Note:- All cook zones will automatically resume to the previous settings.

Cookware for the induction hobs

Cookware for the induction cooking zones must be made of metal and have magnetic properties. The base must also be the correct diameter.

Suitable Cookware for Induction Hobs	Unsuitable Cookware
Enamelled steel pots with a thick base	Pots made of copper, stainless steel, aluminium, oven-proof glass, wood, ceramic and terra-cotta.
Cast iron pots with an enamelled base	
Pots made of multi layer stainless steel, rustproof ferrite steel or aluminium with a special base	
Pans marked for use with induction	

How to establish the suitability of a pan

Check your pans with a magnet. If it sticks and it's the correct diameter, it's suitable for use with induction. Also with pans that bear the symbol for suitability for cooking with induction.

Note - when using certain pans, you may get various noises from the pans. This is due to the design of the pans and does not effect the performance or safety of the hob.

Pans should not be allowed to come into contact with coloured trims during use as this may cause discolouration of the surface

USING THE HOB

Child Lock

This feature is to help prevent accidental switching on of the hob, especially by young children.

To activate:

Press the key lock button and pause button together, and then release them. Complete activation by pressing the pause button again.

To deactivate:

Press the key lock button and pause button together, and then release them. Complete activation by pressing the key lock button again.

Residual Heat indicators

If when the cook zone is switched off the glass surface is above 60°C, H will be displayed in the cook zone display until the glass surface drops below approximately 55°C.

This feature not only warns you against hot surfaces but also indicates that there is residual heat which can be used as temporary warm zone.

Note - The cook zone itself does not heat up, but the ceramic glass does get hot because of the hot pan conducting heat back onto the hob glass.

Overheat Pan Protection

The hob is equipped with additional safety systems that help to prevent cookware from overheating, providing an additional level of safety not available on conventional hobs (such as gas and ceramic hobs).

Approximate Glass Surface Temperature (°C)	Intelligent hob safety system
200	Reduces Power Boost setting to Power Level 9
250	Reduces power to 60% of power level setting
270	Switches cook zone off
300	Switches whole appliance off

Note - The safety temperature control of the pans is only possible with quality flat bottomed pans suitable for induction cooking. Poor quality pans can create air gaps between the glass and the pan, which affects the accuracy of the temperature control.

Auto Stand by (Holiday Shut Down)

The hob will automatically switch itself off if left unattended.

Cooking guide

For best cooking results, follow the examples in the guide below, bearing in mind that settings 8 and 9 are maximum positions and should only be used for deep frying and bringing up to the boil quickly.

USING THE HOB

Preparation	Very fast frying		Fast	Medium		Slow	Simmering, re-heating		Keeping warm
	9	8	7	6	5	4	3	2	1
Soup									
Thin soup					✓				
Thick soup						✓			
Fish									
Court-Bouillon			✓						
Deep fried					✓				
Sauces									
Thick, flour based							✓		
Buttery, containing eggs								✓	
Vegetables									
Spinach				✓	✓				
Pulses							✓		
Boiled potatoes				✓	✓				
Carrots				✓	✓				
Saute potatoes						✓			
Frozen vegetables									
Meat									
Thin cuts of meat	✓								
Fried steak		✓							
Other types of cooking									
Deep frying: frozen chips	✓								
Deep frying: fresh chips	✓								
Pressure cooking	✓				✓				
Stewed fruit	✓	✓							
Pancakes								✓	
Custard									✓
To melt chocolate									✓
Jam							✓		
Milk				✓					
Fried eggs				✓					
Pasta	✓								
Re-heating baby food							✓		
Rice pudding								✓	
Keeping food warm									✓
Stews								✓	

USING THE HOB

Troubleshooting with the Induction Hob

Code	Problem	Possible Cause	Solution
	Hob is not working  in display	Child lock is activated	Deactivate child lock
	Power boost not working	The appliance is hot, power boost is deactivated when the appliance is hot to protect the electronics and prevents the pans from overheating	Allow the appliance to cool
ER21	Control unit cuts off after program setting	Electronics overheating	Allow the appliance to cool
ER400			Check mains cable connection and terminals at the terminal block are wired correctly
E2	Overheating of induction coil	Pan overheating	Remove pans and allow to cool
E8	Fan blocked or faulty	Fan inlets are blocked or faulty fans	Check fan inlet at the rear of the appliance

USING THE GRILL - ELECTRIC

BEFORE YOU START GRILLING. . . .

Before you use the grill, make sure you have placed the grill shelf in the position you need as once the grill is on you may injure yourself if you try to move the shelf.

- Do not close the door while the grill is in use.
- Turn the grill control knob to the heat setting you require.
- On Richmond and Gourmet models only, turn the selector control knob to the grilling position, then select the heat setting you require.
- To switch off, return the control knob to the 'off' position.
- The cooling fan will come on during use, and may continue to run for some time afterwards.
- To adjust your results, you can turn the grid over, or remove it altogether.

If your grill is a dual grill:

- The dual grill uses all of the top element and is ideal for grilling large quantities of food.
- The single grill uses part of the element only, and is better suited to grill smaller amounts of food.

The grill pan

This appliance comes with a grill pan and a grid.

A grill pan handle can be purchased as an optional extra from our spares department quoting the numbers below.

Handle - 082283705

Handle grip - 082469100

Complete grillpan pack - 012635666

Contact details can be found on the customer care page.

Shelf & Grid adjustments

Speed of grilling can be adjusted by changing the shelf position or the turning the grill pan grid

- High: For thin foods and toasting.
- Low: For thicker meat pieces.

Aluminium Foil

Never cover the grill pan or grill trivet with foil, or allow fat to build up in the grill pan, as this creates a fire hazard.



Warning: Accessible parts may become hot when the grill is in use. Children should be kept away



Types of grill

Fixed rate grill: has a full 'on' setting and 'off'.

Variable rate grill:

has adjustable heat settings 1 (low) to 8 (high) or 5 (high) - depending on the model.

Single grill: has one grill element. The grill pan trivet **MUST** be inverted when using the single grill function.

Dual grill: has two grill elements which can be used together, or as a single grill.



For best results:
Pre-heat the single grill for 5 minutes and the dual grill for 3 minutes.

USING THE GRILL - ELECTRIC



As with any cooking guide, all times are approximate and can be adjusted to suit personal taste.

Food Type	Time Approx (mins)
Bacon	8-15
Sausages	12 - 15
Chops <ul style="list-style-type: none">• Lamb• Pork	10 - 15 15 - 25
Toast <ul style="list-style-type: none">• 2 rounds• 4 rounds	1 - 2 (per side) 1 - 2 (per side)
Bread products <ul style="list-style-type: none">• Buns• Tea cakes	1 - 2 (per side) 1 - 2 (per side)
Cheese on toast <ul style="list-style-type: none">• 2 rounds• 4 rounds	4-5 4-5
Fish <ul style="list-style-type: none">• fillets	10 - 15
Chicken <ul style="list-style-type: none">• fillets	20 - 30
Beef Steaks <ul style="list-style-type: none">• rare• medium• well done	7 - 10 10 - 15 15 - 20
Gammon Steaks	12 - 15

USING THE TOP OVEN - ELECTRIC (if fitted)

When you are cooking keep children away from the vicinity of the oven.

Caution: The top element gets extremely hot when in use, so take extra care to avoid touching it.

The top oven is a conventional oven.

Note: The top oven is not controlled by the programmer (if fitted).

To turn on the top oven

Turn the temperature control knob until the required temperature is selected.

The red thermostat indicator will come on until the selected temperature is reached, and then go off; it will turn on and off periodically as the thermostat operates to maintain the selected temperature.

To switch off, return the top oven control knob to the off position.

Important: Never put items directly on the base of the oven, or cover the oven base with foil, as this may cause the element to overheat. Always position items on the shelf.

The cooling fan

When the top oven is switched on, you will hear the cooling fan come on - this keeps the fascia and control knobs of the appliance cool during cooking. The fan may continue to operate for a period after the oven control has been switched off.

Preheating

The oven must be preheated when cooking frozen or chilled foods, and we recommend preheating for yeast mixtures, batters, soufflés, and whisked sponges.

Preheat the oven until the indicator light switches off for the first time, this will take up to 15 minutes depending on the temperature selected.

If you are not preheating the oven, the cooking times in the following guide may need to be extended, as they are based on a preheated oven.

Shelf positions

There are either 3 or 4 shelf positions, depending on which model you have purchased. These are counted from the bottom of the oven upwards, so shelf position 1 is the lowest.

When cooking frozen or chilled food, use the highest possible shelf position, while allowing some clearance between the food and the top element.

The oven shelf must be positioned with the up-stand at the rear of the oven and facing up. Position baking trays and roasting tins on the middle of the shelves, and leave one clear shelf position between shelves, to allow for circulation of heat.

When using the top oven

As part of the cooking process, hot air is expelled through a vent at the top of the oven(s). When opening the oven door, care should be taken to avoid any possible contact with potentially hot air, since this may cause discomfort to people with sensitive skin. We recommend that you hold the underneath of the oven door handle.

USING THE TOP OVEN - ELECTRIC (if fitted)

TOP OVEN BAKING GUIDE

Cooking times

These times are based on cooking in a preheated oven.

These cooking times are approximate, because the size and type of cooking dish will influence time as personal preferences.

Shelf positions

As a general guide, when cooking frozen or chilled food, use the highest possible shelf position, while allowing some clearance between the food and the top element. Follow the instructions given on packaging.

Cooking temperatures

The temperature settings and time given in the Baking Guides are based on dishes made with block margarine. If soft tub margarine is used, it may be necessary to reduce the temperature setting. If a recipe gives a different temperature setting to that shown in the guide, the recipe instruction should be followed.

Because the top oven is more compact, it may be necessary to reduce cooking temperatures specified in recipes by up to 20°C.

Use the baking guide as a reference for determining which temperatures to use.

Item	Temperature (°C)	Shelf Position	Approximate cooking time
Small cakes	180	1	15 - 20 mins
Victoria sandwich (2 x 180mm / 7")	160	1	20 - 25 mins
Swiss roll	200	1	8 - 12 mins
Semi rich fruit cake (180mm x 7")	140	1	2¼ - 2¾ hours
Scones	215	1	10 - 15 mins
Meringues	90 - 100	1	2 - 3 hours
Shortcrust pastry	200 - 210	1	Depends on size & type of cooking dish & also the filling
Puff / flaky pastry	200 - 210	1	
Choux pasrty	200 - 210	1	
Biscuits	160 - 200	2	10 - 20 mins
Sponge pudding	150	1	30 - 45 mins
Milk pudding	140	1	2 - 2½ hours

USING THE MAIN OVEN - ELECTRIC

Accessible parts may be hot when the oven is used. Young children should be kept away.

To switch on the oven

Turn the oven control knob(s) to the required setting.

The red thermostat indicator (if fitted) will come on until the selected temperature is reached and then go off; it will turn on and off periodically as the thermostat operates to maintain the selected temperature.

To switch off, return the control knob to the off ● position.

When using the oven

As part of the cooking process, hot air is expelled through a vent in the oven. When opening the oven door, care should be taken to avoid any possible contact with potentially hot air, since this may cause discomfort to people with sensitive skin. We recommend that you hold the underneath of the oven door handle.

PREHEATING

Fanned oven

When cooking sensitive items such as soufflé and Yorkshire puddings or, when cooking bread, we recommend that the oven is preheated until the neon switches off for the first time. For any other types of cooking, a preheat may not be required.

Conventional oven

Preheating is always required

Manual Operation (fanned only)

The programmer must be set to manual operation before the main oven can be used. If A (Auto) is on the programmer display, return the oven to manual by pressing the up and down buttons simultaneously. Any programme which has been set is cancelled.

The cooling fan

The cooling fan may operate when the main oven is on and may continue to operate for a period after the oven has been switched off.

OVEN FURNITURE

Oven shelves

The oven shelf must be positioned with the upstand at the rear of the oven and facing upwards.

Position baking trays and roasting tins on the middle of the shelves.

Baking tray and roasting tins

For best cooked results and even browning, the recommended size baking trays and roasting tins that should be used are as follows;

Baking tray 350mm x 250mm

This size of baking tray will hold up to 12 small cakes.

Roasting tin 370mm x 320mm

We recommend that you use good quality cookware. Poor quality trays and tins may warp when heated, leading to uneven baking results.

USING THE MAIN OVEN - ELECTRIC

Slow cooking (S Setting or 100°C)

- Make sure that frozen foods are thoroughly thawed before cooking.
- Do not slow cook joints of meat or poultry weighing more than 2¼kg/4½lb.
- Preheat the oven to 170°C and cook for 30 minutes, then adjust the oven control to (S) or 100°C (slow cook setting) for the remainder of the cooking time.
- Slow cooking times will be about 3 times as long as conventional cooking times.
- Do not open the oven door unnecessarily during slow cooking, as this will result in heat loss at low temperatures.
- Always use dishes with tightly fitting lids. To rectify badly fitting lids, place foil over the dish underneath the lid.

Aluminium foil

Use foil only to cover food or cooking dishes, using foil to cover the shelves or oven base creates a fire hazard.

Cooking with a fanned oven

As this is a high efficiency oven, you may notice the emission of steam from the oven when the door is opened. Please take care when opening the door.

If you are used to cooking with a conventional oven you will find a number of differences to cooking with a fan oven which will require a different approach:

There are no zones of heat in a fan oven as the convection fan at the back of the oven ensures an even temperature throughout the oven.

This makes it ideal for batch baking - eg; when planning a party as all the items will be cooked within the same length of time.

Foods are cooked at a lower temperature than a conventional oven, so conventional recipe temperature may have to be reduced. Please refer to the conversion chart.

Preheating is generally not necessary as a fan oven warms up quickly.

There is no flavour transference in a fan oven, which means you can cook strong smelling foods such as fish at the same time as mild foods - eg; milk puddings.

When batch baking foods that will rise during cooking - eg; bread - always ensure that enough space has been left between the shelves to allow for the rise.

Notes:

When 2 or more shelves are being used, it may be necessary to increase the cooking time slightly.

Because the 2 oven shelves are wider than in many ovens, it is possible to cook 2 items per shelf - eg; 2 victoria sandwiches or 2 casseroles.

Although you need to keep in mind the points 'To help the air circulate freely' with careful choice of dishes and tins, it is possible to cook a complete meal, and perhaps something else for the freezer, in the oven at the same time.

When roasting meats, you will notice that fat splashing is reduced, which is due in part to the lower oven temperatures, and will help keep cleaning of the oven to a minimum.

Because a fan oven has an even temperature throughout the oven, there is no need to follow the shelf positions given in the baking guide.

USING THE MAIN OVEN - ELECTRIC

There is no need to interchange dishes onto different shelves part way through cooking, as with a conventional oven.

To help the air circulate freely

Position the shelves evenly within the oven and maintain a clearance from the oven roof and base.

If more than one cooking dish or baking tray is to be used on a shelf, leave a gap of at least 25mm between the items themselves and the oven interior.

Defrosting and cooling in the main oven

To defrost frozen foods, turn the main oven control to the defrost position, place the food in the centre of the oven and close the door.

To cool foods after cooking prior to refrigerating or freezing, turn the main oven control to the defrost position and open the door.

Defrosting times

Small or thin pieces of frozen fish or meat - eg; fish filets, prawns & mince will take approximately 1 - 2 hours.

Placing the food in a single layer will reduce the thawing time.

A medium sized casserole or stew will take approximately 3 - 4 hours.

A 1½kg/3lb oven ready chicken will take approximately 5 hours, remove the giblets as soon as possible.

Be safe

Do not defrost stuffed poultry using this method.

Do not defrost larger joints of meat and poultry over 2kg/4lb using this method.

Never place uncooked food for defrosting next to cooked food which is to be cooled, as this can lead to cross contamination.

Defrosting meat, poultry, and fish can be accelerated using this method but make sure they are completely thawed before cooking thoroughly. Place meat and poultry on a trivet in a meat tin.

MAIN OVEN BAKING GUIDE

Cooking times & temperatures

The temperature settings and times given in the baking guide are based on dishes made with block margarine. If soft tub margarine is used it may be necessary to reduce the temperature setting.

Allow enough space between shelves for food that will rise during cooking.

Do not place items on the oven base as this will prevent air circulating freely.



USING THE MAIN OVEN - ELECTRIC

Note: This is a fanned oven, therefore some adjustment will have to be made to conventional cooking temperatures. The table below shows conventional cooking temperatures, fanned oven temperatures and gas marks. For optimum results,

conventional temperatures need to be converted to fanned oven temperatures.

For example, an item which would normally cook at a conventional temperature of 180 °C, will now cook at the fanned oven temperature of 160°C.

Conventional temperature (°C)	Fanned Oven (°C)	Gas Mark
100	100	1/4
110	110	1/4
130	120	1/2
140	130	1
150	140	2
160	150	3
180-190	160	4-5
200	170	6
220	180	7
230	190	8
250	200	9

Food Type	Temperature settings (°C)		Time Approx.	Shelf Position
	Conv 	Fanned 		
Cakes				
Small cakes	190	160	15 - 25	2 - 4
Victoria sandwich	180	160	20 - 30	3
Semi rich fruit cake	150	125	2.5HRS - 3HRS	2
Christmas cake	150	125	2.5HRS - 3HRS	2
Puddings				
Bread and butter pudding	170	150	45 - 1hr	3
Fruit crumble	200	175	40 - 1hr	3
Miscellaneous				
Yorkshire pudding: large	220	200	40 - 48	4 - 5
small	220	200	15 - 20	4 - 5
Shortcrust pastry	200	180	Depends on filling	4 - 5

USING THE MAIN OVEN - ELECTRIC

Traditional fruit cakes

It should be remembered that ovens can vary over time, therefore cooking times can vary, making it difficult to be precise when baking fruit cakes.

It is necessary therefore, to test the cake before removal from the oven. Use a fine warmed skewer inserted into the centre of the cake. If the skewer comes out clean, then the cake is cooked.

- Follow the temperatures suggested in the recipe and then adjust accordingly to the conversion table.
- Do not attempt to make Christmas cakes larger than the oven can cope with, you should allow at least 25mm (1") space between the oven walls and the tin.
- Always follow the temperatures recommended in the recipe.
- To protect a very rich fruit cake during cooking, tie 2 layers of brown paper around the tin.
- We recommend that the cake tin is not stood on layers of brown paper, as this can hinder effective circulation of air.
- Do not use soft tub margarine for rich fruit cakes, unless specified in the recipe.
- Always use the correct size and shape of tin for the recipe quantities.

Roast turkey

Roasting turkey involves cooking two different types of meat - the delicate light breast meat, which must not be allowed to dry out, and the darker leg meat, which takes longer to cook.

The turkey must be roasted long enough for the legs to cook, so frequent basting is necessary. The breast meat can be covered once browned.

- Always make sure that the turkey is completely thawed and that the giblets are removed before cooking.
- Turkey should be roasted at 160°C - 180°C (fanned) or 180°C - 200°C (conventional) for 20 minutes per 450g (1 lb), plus 20 minutes, unless packaging advises otherwise.
- The turkey can be open roasted, breast side down, for half of the cook time, and then turned over for the remainder of the cooking time.
- If the turkey is stuffed, add 5 minutes per 450g (1 lb) to the cooking time.
- If roasting turkey covered with foil, add 5 minutes per 450g (1 lb) to the cooking time.

To test if the turkey is cooked, push a fine skewer into the thickest part of the thigh. If the juices run clear, the turkey is cooked. If the juices are still pink, the turkey will need longer cooking.

USING THE MAIN OVEN - ELECTRIC

Roasting guide

The times given in the roasting guide are only approximate, because the size and age of the bird will influence cooking times as will the shape of a joint and the proportion of the bone.

Frozen meat should be thoroughly thawed before cooking. For large joints it is advisable to thaw over night.

Frozen poultry should be thoroughly thawed before cooking. The time required depends on the size of the bird - eg; a large turkey may take up to 48 hours to thaw.

Use of a trivet with a roasting tin will reduce fat splashing and will help to keep the oven interior clean. Alternatively, to help reduce fat splashing, potatoes or other vegetables can be roasted around the meat/poultry.

Notes:

- When cooking stuffed meat or poultry calculate the cooking time from the total weight of the meat plus the stuffing.
- For joints cooked in foil or covered roasters, and for lidded casseroles, add 5 minutes per 450g (1lb) to the calculated cooking time.
- Smaller joints weighing less than 1.25kg (2½lb) may require 5 minutes per 450g (1lb) extra cooking time.
- Position the oven shelf so that the meat or poultry is in the centre of the oven.
- It is recommended that the appliance is cleaned after open roasting.

Cook in main oven at: 160°C - 180°C (fanned) 180°C - 200°C (conventional)		Approximate Cooking Time (preheated oven)
Beef	Rare Medium Well done	20 minutes per 450g (1lb), plus 20 minutes 25 minutes per 450g (1lb), plus 25 minutes 30 minutes per 450g (1lb), plus 30 minutes
Lamb	Medium Well Done	25 minutes per 450g (1lb), plus 25 minutes 30 minutes per 450g (1lb), plus 30 minutes
Pork		35 minutes per 450g (1lb), plus 35 minutes
Poultry		20 minutes per 450g (1lb), plus 20 minutes

USING THE OVEN/GRILL - MULTI-FUNCTION

MULTIFUNCTION OVEN (IF FITTED)

The multifunction oven may be controlled by the programmer (see The Programmer/Clock for details).

The programmer, if fitted must be set to manual before it can be used, or programmed.

Switching on the multifunction oven

- Use the function control knob to select the function you wish to use - see the functions table for details.
Note: You can change function during cooking if you wish, as long as the oven is in manual mode.
- Turn the temperature control knob to the temperature you wish to use.
- The thermostat indicator will come on to show that the oven is heating, and once the temperature is achieved, it will go out.
- To switch off the oven, simply turn the control knob back to the '•' position.
- The cooling fan may come on during use, and may continue to run for some time afterwards.

FANNED OVEN (IF FITTED)

Switching on the fanned oven

- Use the main oven control to turn your oven on, and select your temperature.
- The thermostat indicator will come on to show that the oven is heating, and once the temperature is achieved, it will go out.
- To switch off the main oven, simply turn the control knob back to the '•' position.
- The cooling fan will come on during use, and may continue to run for some time afterwards.













Important: Never place food, or dishes on the base of the main oven, the element is here and it will cause over heating.

USING THE OVEN/GRILL - MULTI-FUNCTION

Oven & Grill Functions

The chart below details all of the functions which are available. Your oven may not have all of the functions shown here.

Main Oven Function		Recommended Uses
	Base Heat Only	Used to finish off the bases of food following cooking using the conventional or fanned modes. The base heat can be used to provide additional browning for pizzas, pies and quiche. Use this function towards the end of cooking.
	Top Heat Only	The heat is ideal from browning off the tops of food as it is not as fierce as the grill following conventional or fanned cooking. Provides additional browning for dishes like Lasagna or Cauliflower cheese. Use this function towards the end of cooking.
	Conventional Oven	This function is ideal for traditional roasting. The meat is placed in the middle of the oven, roast potatoes towards the top.
	Intensive Bake	Suitable for food with a high moisture content, such as quiche, bread and cheesecake. It also eliminates the need for baking pastry blind.
	Fanned Grill	The fan allows the heat to circulate around the food. Ideal for thinner foods such as bacon, fish and gammon steaks. Foods do not require turning. Use with the oven door closed.
	Fanned Oven	The even temperature in the oven makes this function suitable for batch baking, or batch cooking foods.
	Defrost	To defrost foods, such as cream cakes/gateaux, use with the oven door closed. For cooling dishes prior to refrigeration, leave the door open.
	Dual Grill	This function cooks food from the top and is ideal for a range of food from toast to steaks. As the whole grill is working, you can cook larger quantities of food.
	Single Grill	For smaller quantities of food, but is still ideal for anything from toast to steaks.
	Base Heat with Fan	Used to cook open pies (such as mince pies) the base element ensures that the base is cooked while the fan allows the air to circulate around the filling - without being too intensive.
	Lights Only	Use when the oven is switched off and cold to aid cleaning the oven cavity.

USING THE OVEN/GRILL - MULTI-FUNCTION

Before you start grilling. . . .

Before you use the grill, make sure you have placed the grill shelf in the position you need as once the grill is on you may injure yourself if you try to move the shelf.

FANNED GRILL (IF FITTED)

- This grill function must be used with the door closed.
- Turn the selector control knob to the grill setting you require (conventional or fanned).
- Turn the temperature selector to heat setting you require in a similar way to the selecting the oven temperature.
- Note: Do not set the temperature any higher than 220°C.

DUAL/SINGLE GRILL (IF FITTED)

- This grill function can be used with the door open, or closed.
- Turn the selector control knob to the grill setting.
- Turn the grill control knob to either the dual or single grill setting. Then select the heat setting.

To switch off, return the control knobs to the 'off' position.

The cooling fan may come on during use, and may continue to run for some time afterwards.

To adjust your results, you can turn the grid over, or remove it altogether.

 **Warning:** Accessible parts may become hot when the grill is in use. Children should be kept away.

Types of grill

Fixed rate grill: has a full 'on' setting and 'off'.

Variable rate grill: has adjustable heat settings
1 (low) to 8 (high) or 5 (high) - depending on the model.

Single grill: has one grill element. The grill pan trivet **MUST** be inverted when using single grill in the main oven.

Dual grill: has two grill elements which can be used together, or as a single grill.

 For best results:
Pre-heat the single grill for 5 minutes and the dual grill for 3 minutes.

If your grill is a dual grill:

- The dual grill uses all of the top element and is ideal for grilling large quantities of food.
- The single grill uses part of the element only, and is better suited to grill smaller amounts of food.
- When grilling with the door closed only the inner part of your grill is used.

The grill neon

When grilling with the door closed, the neon will cycle on and off as the temperature is maintained inside the cavity. If the door is open, it will not cycle on and off.

USING THE OVEN/GRILL - MULTI-FUNCTION

Fanned oven guide

- Some adjustment will have to be made to conventional cooking temperatures.
- The table below shows conventional cooking temperatures, fanned temperatures and gas marks. For optimum results using the fanned oven setting, conventional temperatures need to be converted to the fanned oven temperatures.
- For example an item which would cook at 180°C will now cook at the fanned oven temperature of 160°C.
- This is a high efficiency oven, you may notice an emission of steam when the door is opened.
- When cooking chilled or frozen foods, use the recommended cooking times and temperature on the packaging. Always make sure the food is piping hot throughout before serving.
- There are no zones of heat, and no flavour transfer when using a fanned oven - allowing you to cook a greater variety of foods together.
- If you are cooking on more than one shelf, you may need to slightly increase the cooking time.
- Always make sure that there is enough space between dishes, to allow food to rise, and to air to circulate.

Conventional temp (°C)	'A' Efficiency oven (°C)	Gas Mark
100	100	1/4
110	110	1/4
130	120	1/2
140	130	1
150	140	2
160	150	3
180 - 190	160	4 - 5
200	170	6
220	180	7
230	190	8
250	200	9

USING THE OVEN/GRILL - MULTI-FUNCTION

COOKING GUIDE

Pre-heating

To get the best results from your oven, we recommend pre-heating for around 5 to 15 minutes before placing your dishes in. This is especially important for items which are chilled, frozen, batter based, yeast based or whisked sponges.

If you are using a fanned function, you should still preheat but for a shorter time.

The items in the cooking guide below are based on a pre-heated oven, but can be adjusted to take into account personal taste.

Oven and bake-ware

Always use high quality trays and tins for cooking. Poor quality tins and trays can warp in the oven producing uneven results.

Never use dishes which are cracked, damaged or not oven proof as heating may lead to shattering inside the oven.

OVEN FURNITURE

Oven shelves

The oven shelf must be positioned with the upstand at the rear of the oven and facing upwards.

Position baking trays and roasting tins on the middle of the shelves, and leave one clear shelf position between shelves, to allow for circulation of heat.

Baking tray and roasting tins



For best cooked results and even browning, the recommended size baking trays and roasting tins that should be used are as follows;

Baking tray 350mm x 250mm

This size of baking tray will hold up to 12 small cakes.

Roasting tin 370mm x 320mm

We recommend that you use good quality cookware. Poor quality trays and tins may warp when heated, leading to uneven baking results.

Food Type	Temp. Setting °C			Time Approx.	Shelf Position
	Conv 	Fanned 	Intensive 		
Cakes					
Small cakes	190	175	-	15 - 25	2 & 4
Victoria sandwich	180	160	-	20 - 30	3
Semi rich fruit cake	150	125	-	2½ - 3hrs	2
Christmas cake	150	125	-	2½ - 3hrs	2
Puddings					
Bread & butter pudding	170	150	-	45 - 1hr	3
Fruit crumble	200	175	-	40 - 1hr	3
Miscellaneous					
Yorkshire pudding: large	220	200	200	40 - 45	4 - 5
small	220	200	200	15 - 20	4 - 5
Shortcrust pastry	200	180	180	depends on filling	4 - 5

USING THE OVEN/GRILL - MULTI-FUNCTION

Roasting Guide

- Roasting times depend on the weight, shape and texture of the meat and personal preference. In order to calculate the roasting time, weigh the meat or poultry, including the stuffing, and follow the times given below.

Meat joints (including chicken) should be roasted at 180 - 200°C Conventional/ 160 - 180°C Fanned for 20 - 30 mins per 450g/1lb, plus 20 minutes on shelf position 2.

- Use of a trivet with the roasting tin will reduce fat splashing during open roasting, and will help to keep the oven interior clean.
- The use of a roasting tin larger than that supplied is not advised, as this may impair performance and lead to extended cooking times.
- Frozen meat must be thoroughly thawed before cooking. For large joints, it is advisable to thaw overnight.
- Frozen poultry must be thoroughly thawed before cooking. The time required depends on the size of the bird - eg: a large turkey may take up to 48 hours to thaw.
- When cooking stuffed meat or poultry, calculate the cooking time from the total weight of the meat plus the stuffing.
- Cooking joints in foil, covered roasters, lidded casseroles, or roasting bags will help to reduce meat shrinkage, give a more moist result and may reduce fat splashing. However, a slightly longer cooking times will be required, add 5 - 10 minutes per 450g (1lb) to the calculated cooking time. When using roasting bags do not exceed the temperatures recommended by the manufacturer, and do not allow the roasting bag to touch the sides or top of the oven.

USING THE OVEN/GRILL - MULTI-FUNCTION

Roasting Guide

Roast turkey

- Roasting turkey perfectly involves cooking two different types of meat - the delicate light breast meat, which must not be allowed to dry out, and the darker leg meat, which takes longer to cook.
- The turkey must be roasted long enough for the legs to cook, so frequent basting is necessary. The breast meat can be covered once browned.
- Turkey should be roasted at 180°C - 190°C Conventional / 160°C - 180°C Fanned for 20 mins per 1lb, plus 20 minutes.
- The turkey can be open roasted, breast side down, for half of the cook time, and then turned over for the remainder of the cooking time.
- If the turkey is stuffed, add 5 minutes per 1lb to the cooking time.
- If roasting turkey covered with foil, add 5 minutes per 1lb to the cooking time.
- To test if the turkey is cooked, push a fine skewer into the thickest part of the thigh. If the juices run clear, the turkey is cooked. If the juices are still pink, the turkey will need longer cooking. Always make sure that the turkey is cooked properly before serving.

Turkey Roasting times.

Most Turkeys are measured by the kilogram. Timing should be calculated in either of these ways:

40 minutes per 1kg plus 10 minutes per 1/4 kg.

or

20 minutes per 1lb, plus 20 minutes.

The maximum size Turkey for this appliance is: 20lbs approximately 9kgs.

Please do not attempt to roast a Turkey larger than this, as the results cannot be guaranteed.

USING THE OVEN/GRILL - MULTI-FUNCTION

General Baking Guide

Trouble-shooting - fruit cakes

PROBLEM	POSSIBLE CAUSE
Fruit sinking to the bottom	Low oven temperature which may cause the cake to take longer to set, allowing the fruit to sink. Or, too much liquid, or raising agent. The fruit may not have been properly washed and dried.
Cake sinking / dipping in the centre	Too much raising agent in the mixture. Too hot, or too cool an oven. Or, not enough liquid or insufficient creaming.
Surface cracks	Too small a tin, or too much mixture in the tin. Too much raising agent in the mix, plus not enough liquid or insufficient creaming. The oven may be too hot.
Hard outer crust with a damp patch inside	Oven too hot, therefore the cake baked too quickly. Too much sugar, or insufficient liquid.
Burnt outside	Oven temperature too high. Oven too small for the size of cake. Insufficient protection around the tin. Cake baked on too high a shelf.
Texture with pronounced holes.	Too much raising agent. Flour unevenly mixed.
Texture too close and cake insufficiently risen.	Not enough raising agent. Not enough liquid. Too cool an oven. Insufficient creaming.
Cake crumbles when cut	Not enough liquid. Baked for too long. Not enough sugar. Too much baking agent.
Too dry	Over baking. Insufficient egg or liquid. Too much raising agent.

Trouble-shooting - sponge cakes

Domed top	Insufficient creaming of mixture. Cake baked on too high a shelf position, or at too high a temperature. Paper liners can cause the outer edge not to rise and the centre to peak.
Hollowed / sunken top	Too much raising agent. Oven temperature too low, or incorrect shelf position. Cake removed from oven before it's cooked. Use of soft tub margarine.
Very pale, but cooked	Oven temperature too low. Baked too low in the oven
Overflowing tin	Tin too small for the amount of mixture

USING THE OVEN/GRILL - MULTI-FUNCTION

Cooling and Defrosting Function

- To cool foods quickly straight after cooking, but before refrigerating or freezing, turn the oven control to the defrost position, and open the door.
- To defrost frozen foods, turn the oven control to the defrost position, place the food in the centre of the oven and close the door.

Defrosting times

- Small or thin pieces of frozen fish or meat - eg; fish fillets, prawns, and mince will take approximately 1 - 2 hours. Placing the food in a single layer will reduce the thawing time.
- A medium sized casserole or stew will take around 3 - 4 hours.
- A 1½kg / 3lb oven ready chicken will take around 5 hours, remove the giblets as soon as possible.
- Always check foods are thoroughly defrosted before cooking.

Be safe

- Do not defrost stuffed poultry using this method.
- Do not defrost larger joints of meat and poultry over 2kg / 4lb using this method.
- Never place uncooked food for defrosting next to cooked food which is to be cooled, as this can lead to cross contamination.
- Defrosting meat, poultry and fish speeded up using this method, but make sure they are completely thawed before cooking thoroughly.
- Place meat and poultry on a trivet in a meat tin, to catch the juices from the defrosting process.

USING THE OVEN - SLOW COOK (if fitted)

Introduction

One of your oven compartments is an electric oven which provides a gentle heat suitable for slow cooking or keeping food warm. The oven is operated by a button at the right hand of the fascia, and a red neon will illuminate to show that the oven is switched on. Please check which side the slow cook oven is on, by looking at the specification at the front of this handbook.

The slow cook element is positioned in the base of the lower compartment- always make sure that the prepared cooking pot is placed centrally on the base of this compartment.

Do not use either compartment to store food or canned items.

Do not use the upper compartment for slow cooking, or food warming.

Cooking times

The cooking time varies according to the type of food being cooked, and experience will show how long foods should be cooked for, according to personal taste and preference.

In general foods should be cooked for at least 5 hours, and maybe left up to 8-10 hours without spoiling if covered. As a guide, foods cooked using the slow cook oven will take about three times longer than they would in a conventional oven.

Utensils

Any oven proof utensils maybe used for slow cooking, provided they have a close fitted lid.

To rectify a badly fitting lid a piece of cooking foil may be placed over the dish, under the lid.

For convenience and to save washing up, the most useful utensils for slow cooking are the flame proof type which can

be used over direct heat and for oven cooking, and are sufficiently attractive to use as serving dishes.

Keeping food warm

Turn the oven on, and allow to pre-heat for 20 minutes before placing the food in the oven. If food is to be kept moist then it is important to cover the dish or plate to prevent food from drying out. This can be done using aluminium foil if the dish does not have a lid.

Do not use cling film to cover food as it cannot withstand the heat produced in the oven.

Some foods are best left uncovered if you wish to keep the food dry and crisp.

Do not add gravy to plated meals until serving.

Carved meat should be placed on one plate and covered, adding just one tablespoon of gravy to keep it moist. When keeping plated meals warm it is recommended that the food is placed on hot rather than cold plates.

Slow Cooking

Slow cooking has always been the best way to prepare a nutritious hot meal with the minimum of preparation and maximum time away from the kitchen. The benefits of slow cooking have been recognized by cooks for centuries, and are still appreciated by cooks today.

USING THE OVEN - SLOW COOK (if fitted)

The advantages of slow cooking are as follows:

- Food can be left to cook unattended for several hours and will keep hot for several hours if left covered, without spoiling for a further 2-3 hours, so foods can be left to cook while you are out for the day, or over night.
- Inexpensive cuts of meat become deliciously tender when slow cooked.
- Slow cooking will also produce moist, tender "roasts" with minimal meat shrink-age and reduced oven soiling.
- Dishes such as soups, vegetables, puddings savory dishes and preserves are also suitable for slow cooking.
- There is no topping up of steamers, steam filled kitchens or constant checking to do.

Using the slow cook oven

Turn the oven on and preheat for 20 minutes. Always place the prepared cooking pot centrally on the base of the oven. Follow the guide lines for the best results.

- The maximum capacity of oven proof dishes should be no more than 2.5 litres (4.5 pints).
- Please note: The more you fill the dish/pot the longer it will take to cook.
- Cooking times will vary depending on the size and shape of the meat, or poultry.
- Always bring soups, casseroles and liquids to the boil before placing in a preheated oven. To give more colour to meat or poultry, fry the meat to brown and add to stock which is hot.
- All meat and poultry recipes need a minimum of 5 hours to cook.
- Make sure all frozen ingredients are

well thawed out.

- Always ensure that frozen poultry has thoroughly defrosted in a refrigerator and all ice crystals have melted.
- Cut root vegetables into smaller pieces as they take longer than meat to cook.
- If possible they should be sauteed for 2-3 minutes before slow cooking.
- Ensure that root vegetables are always at the bottom of the pan immersed in the cooking liquid.
- A meat thermometer should be used when cooking pork joints and poultry. The internal temperature of the food should reach 88 °C,
- Stuffed meat or stuffed poultry should not be slow cooked. Cook any stuffing separately.
- Cover casseroles with a lid, or foil to prevent loss of moisture.
- Adjust seasonings and thickenings at the end of cooking time.
- Dried red kidney beans must be boiled for a minimum of 10 minutes following soaking before inclusion in any dish.
- Opening the door during cooking, leads to heat loss, and will lead to increased cooking times.

USING THE CLOCK/PROGRAMMER-ELEC(IF FITTED)

THE ALTERNATIVE PROGRAMMERS

There are two types of programmer covered in this section - push button & touch control. Both programmers have the same symbol variants & functions but may vary in their method of operation.

The push button programmer

Symbol	Symbol	What is it?
∨	-	<p>Down/minus</p> <p>Used to decrease cook / end time, remove minutes from the minute minder and adjust the time of day. Also for listening to and setting the alarm tone.</p>
^	+	<p>Up/plus</p> <p>Used to increase cook / end time, add minutes to the minute minder and adjust the time of day.</p>
<p>FUNCTION or</p> 	MODE	<p>Function button</p> <p>Used to select the functions available on this timer.</p> <p>Press once for: Minute Minder. Press twice for: Cook time Press three times for: End time.</p> <p>How to use these functions is explained later on in this section.</p>

The 'function' button in the centre is used for setting the minute minder and setting up the automatic cooking. See below for details.

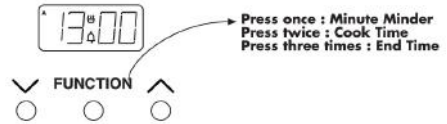

Symbols on the LED display.

This 'A' symbol appears when either a semi, or fully automatic program is selected. This symbol will flash while a program is being set.

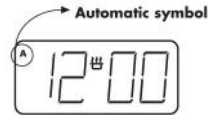

Once a program is set the symbol will light up, and remain lit until the alarm sounds, or the program is cancelled.

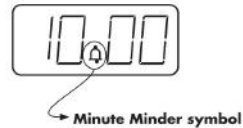

This bell symbol appears when the Minute Minder function has been selected.

While the Minute Minder is being set, the Bell symbol flashes. Once the length of time is set, the Bell symbol remains lit until the time runs down, or the function is cancelled.



This message and 'A' symbol appear when you are asked to set the length of time you require the oven to cook automatically for. Using the Up and Down buttons adjusts this accordingly.



USING THE CLOCK/PROGRAMMER-ELEC(IF FITTED)

This message and 'A' symbol appear when you are asked to enter in an end time, or when you would like the oven to switch itself off.

To set the time of day

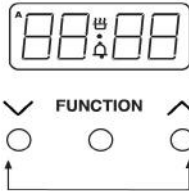

- Press the Up and Down buttons together for a few seconds, and release.
- The 'A' in between the numbers on the LED Display will begin to flash.
- While the 'A' is flashing it is possible to adjust the time using the Up and Down buttons. Once the time has been set, allow approximately 30 seconds before using any of the other timer functions. This ensures that the time will remain correct.

To select an alarm tone

There are three tones to choose from.

- Press and hold the down button to listen to the first tone.
- Release the down button and press it again to listen to the second tone etc.
- Releasing the down button after the tone has sounded will automatically select that tone.

Setting the minute minder

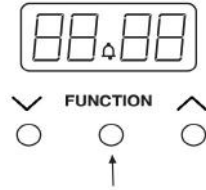

- To set the Minute Minder, press the Function button once. The bell symbol will appear and start flashing. The flashing only lasts for 5 seconds so the time must be set within this time frame.
- Use the Up and Down button to set the length of time required. Once this has been done, the Minute Minder is set.
- When the desired length of time has counted down the alarm will sound.
- To cancel the tone, press any of the buttons.
- To cancel the Minute Minder at any time, press the Up and Down buttons together.

USING THE CLOCK/PROGRAMMER-ELEC(IF FITTED)

Semi-automatic cooking

There are two types of semi automatic cooking available on this appliance.

The oven must be switched on, and in use to use either of these functions successfully.

The Duration method allows you to set the oven for a specific length of time. If a dish needed 2 hours to cook, then it would be possible for you to set the oven to turn off 2 hours later. This allows you to be sure that your food will be cooked for a set length of time and no longer.

The End Time method allows you to enter a specific time when you would like the oven to switch off. If you wish to leave the oven unattended, then it offers peace of mind that the oven will have turned itself off at the set time.

However, once the program is set then it cannot be adjusted. Extra time cannot be added, nor can the end time be extended.

To cancel the semi automatic programs, press both the Up and Down buttons together. This can be done at any time during the cooking process. Then if necessary, re program.

For the instructions on how to use both of these functions, please see the following page.

Fully automatic cooking

This function incorporates both a duration and an end time and is meant to be used when you wish to delay the start time.

We recommend that the first few times this function is used you are in the house, this will familiarise you with your oven and prevents food from being over cooked or under cooked.

Care must be taken when selecting foods for this function, it is not recommended for certain food items which may spoil, or are sensitive to being left.

It is also advisable to set the end time to be as close to your return as possible to prevent food being left standing.

USING THE CLOCK/PROGRAMMER-ELEC(IF FITTED)

SEMI-AUTOMATIC COOKING

The duration method

- Press the Function button twice,(1) which will skip past the Minute Minder.
- The LED display will flash the word 'dur', (2) and the 'A' will flash on the left hand side of the display.
- Use the Up and Down buttons to set the length of time you want to cook for.(3) This must be done within 5 seconds or the time of day will show again.

Once this is done the oven will automatically switch off once the time has elapsed, and the alarm will sound.

To switch off the alarm, press any button.
To view any remaining time press the function button twice.

The end time method

- Press the Function button three times, which will skip past the Minute Minder and the Duration programmer. (4)
- The LED display will flash the word 'End' and the 'A' will flash on the left hand side of the display. (5)
- Use the Up and Down buttons to select the time the oven is required to turn off. (6)

Once this is done the oven will turn itself off at the time you have selected.

To switch off the alarm, press any button.

1. The Duration method

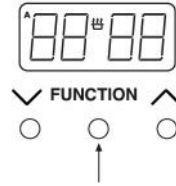

2.



3.

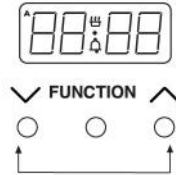

4. The End Time method

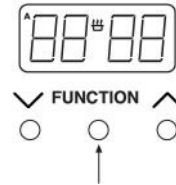

5.



6.

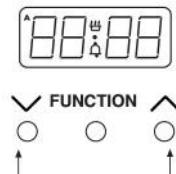

USING THE CLOCK/PROGRAMMER-ELEC(IF FITTED)

FULLY AUTOMATIC COOKING (EXAMPLE)

This programming method is best suited for when a delayed start time is required. Unlike the semi automatic methods this requires both the duration and the end time to be entered. The timer will work out the start time and begin cooking.

- Press the function button twice to select the length of time your food will need. (7)
- The 'A' on the left hand side will flash and the 'dur' message will flash up. (8)
- Using the Up and Down buttons set the time you require within 5 seconds of the 'dur' message. (9)
- Press the function button three times until the 'A' flashes again and the 'End' messages appears. (10) & (11)
- Using the Up and Down buttons, set the time you would like the oven to switch off. (12)
- Set the temperature of the oven and place the food inside.

While the automatic function is running, the 'A' will appear statically on the display, with the time.

Try to keep the end time as close to when you expect to return, this will prevent cooked food from being left standing in a warm oven.

The timer will calculate the appropriate start time.

To switch off the alarm, press any button.

7

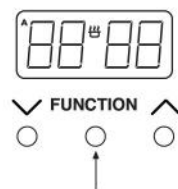

8

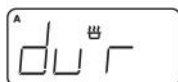

9

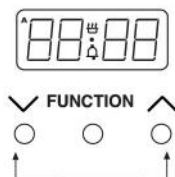

10

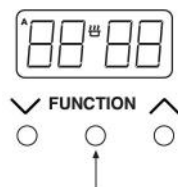

11



12

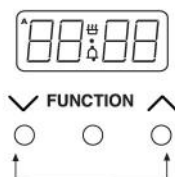

USING THE CLOCK/PROGRAMMER-ELEC(IF FITTED)

The touch control programmer

There are three touch control icons for this timer - the table below shows you what the symbols look like, depending on the model type, & their functions.

Note - some functions require you to 'touch & hold' an icon for a few seconds, whilst others require you to just 'touch' the icon without holding.

The 'function' icon in the centre is used for setting the minute minder & setting up the automatic cooking - see below for details.

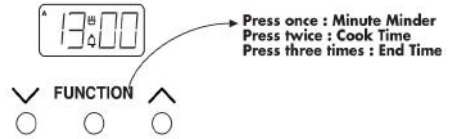

Sym- bol	Sym- bol	What is it?
∨	-	Down/minus Used to decrease cook / end time, remove minutes from the minute minder and adjust the time of day. Also for listening to and setting the alarm tone.
∧	+	Up/plus Used to increase cook / end time, add minutes to the minute minder and adjust the time of day.
FUNC- TION	MODE	Function icon Used to select the functions available on this timer. Touch once for: Minute Minder. Touch twice for: Cook time Touch three times for: End time. How to use these functions is explained later on in this section.

Symbols on the LED display.

This 'A' symbol appears when either a semi, or fully automatic program is selected. This symbol will flash while a program is being set.

Once a program is set the symbol will light up, and remain lit until the alarm sounds, or the program is cancelled.

This Bell symbol appears when the Minute Minder function has been selected.

While the Minute Minder is being set, the Bell symbol flashes. Once the length of time is set, the Bell symbol remains lit until the time runs down, or the function is cancelled.

This message and 'A' symbol appear when you are asked to set the length of time you require the oven to cook automatically for. Using the Up and Down icons adjusts this accordingly.

This message and 'A' symbol appear when you are asked to enter in an end time, or when you would like the oven to switch itself off.

USING THE CLOCK/PROGRAMMER-ELEC(IF FITTED)

Setting the time of day

Touch & hold the centre (function) icon for a few seconds until the ● symbol between the numbers on the LED display flashes.

While the ● symbol is flashing, you can adjust the time of day by touching the plus & minus icons. Please note: the hours & minutes adjust quickly.

Important - once the time of day has been set, allow approximately 30 seconds before using any of the other programmer functions. This ensures that the time of day will remain correct.

Setting an alarm tone

Touch & hold the plus & minus icons simultaneously until the ● symbol flashes & you hear a beep - then touch the centre (function) icon.

Touch the minus icon to select the tone.

You can change the tone by repeatedly touching the minus icon - there are three tones to choose from.

Setting the minute minder

To set the minute minder, touch & hold the centre (function) icon until the bell symbol appears & begins to flash. Important - the flashing will last for approximately five seconds, so any setting must be carried out within this time frame.

Touch the plus & minus icons to set the length of time required. Once this has been done, the minute minder is set.

When the desired length of time has counted down, the alarm will sound. To cancel the tone, touch & hold any of the icons.

To cancel the minute minder at any time, touch & hold the plus & minus icons together.

Semi-automatic cooking

Method 1 - duration (switch off after set time period):

Touch & hold the centre (function) icon; the bell will flash & you will hear a beep. Touch the centre (function) icon again - this will skip past the minute minder function.

The display will flash the word 'dur' & the 'A' will flash on the left hand of the display.

Use the plus & minus icons to set the length of time you want to cook for. The flashing will last for approximately five seconds, so the setting must be done within this time frame or the time of day will show again.

Once the duration has been set, the oven will automatically switch off. When the set time has elapsed the alarm will sound. To switch the alarm off, touch any icon.

To view any remaining time, touch & hold the centre (function) icon & touch again.

To cancel the semi-automatic programme at any time, touch the plus & minus icons together.

Method 2 - end time (switch off at a set end time):

Touch & hold the centre (function) icon; the bell will flash & you will hear a beep. Touch the centre (function) icon again - twice - this will skip past the minute minder & duration functions.

The display will flash the word 'End' & the 'A' will flash on the left hand of the display.

USING THE CLOCK/PROGRAMMER-ELEC(IF FITTED)

Use the plus & minus icons to select the time the oven is required to switch off.

Once this is done the oven will switch itself off at the pre-selected time. To turn the alarm off, touch any icon.

To cancel the semi-automatic programme at any time, touch the plus & minus icons together.

Fully automatic cooking

This function allows the cooker to switch on & off automatically. It requires both the duration & the end time to be entered. The timer will work out the start time & begin cooking.

Touch & hold the centre (function) icon; the bell will flash & you will hear a beep. Touch the centre (function) icon again - this will skip past the minute minder function.

The display will flash the word 'dur' & the 'A' will flash on the left hand of the display.

Use the plus & minus icons to set the length of time you want to cook for. The flashing will last for approximately five seconds, so the setting must be done within this time frame or the time of day will show again.

Touch the centre (function) icon again - this skips past the minute minder & duration functions.

The display will flash the word 'End' & the 'A' will flash on the left hand of the display.

Use the plus & minus icons to select the time the oven is required to switch off.

Set the temperature of the oven & place the food inside. The timer will calculate the start time.

When this is done the oven will turn itself off at the time you have selected. To switch off the alarm, touch any icon.

To cancel the automatic programme at any time, touch the plus & minus icons together.

USING THE MINUTE MINDER (IF FITTED)

Initial display

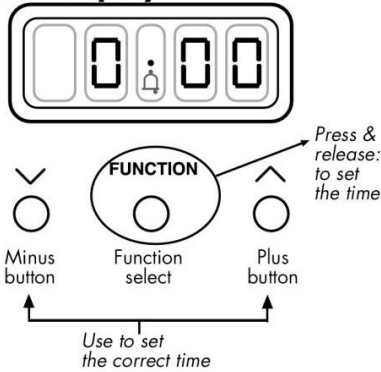

Setting the minute minder

- Press and release the plus button to change the display from clock to minute minder - the bell symbol will light.
- Use the plus and minus buttons to set the length of time before the alarm tone will sound. The display will increase/decrease in units of 10 seconds up to 99 minutes 50 seconds, and in units of 1 minute from 1 hour 40 minutes upwards. The maximum period which may be set is 10 hours.

The display format will change after 99 minutes and 50 seconds to 1 hour and 40 minutes.

During countdown, the minute minder has priority on the display, which will show (in minutes : seconds, or hours : minutes) the time remaining.

When countdown is complete, the tone will sound for 7 minutes, or it can be reset with one touch of any button.

To cancel the minute minder at any other time, run down the set time with the minus button.

The display will revert to show the time of day.

MECHANICAL MINUTE MINDER

Turn the minute minder control knob fully to the maximum setting, then turn back to the desired setting.

When countdown is complete, the timer will give a audible signal for a few seconds before it stops.

ELECTRONIC MINUTE MINDER

The digital timer enables you to set the time of day (24 hour clock) and the minute minder alarm.

Setting the "Time of Day"

- Switch on the electricity supply to the appliance.
- The display will flash.
- Press and release the time of day button.
- Set the time of day with the plus and minus buttons.
- The time will be set 7 seconds after the last plus or minus operation.

Alarm tones

After setting the time of day, you can select one of three alarm tones.

Press the minus button to listen to the first tone, then release the minus button and press it again to listen to the second tone, etc.

Releasing the minus button after a tone has sounded will automatically select that tone.

CLEANING

General

- It is important to clean the product regularly as a build up of fat can affect its performance or damage it and may invalidate your guarantee.
- Always switch off your appliance and allow it to cool down before you clean any part of it.
- Do not use undiluted bleaches, products containing chlorides, wire wool or abrasive cleaners on aluminium, stainless steel, or plastic/painted parts as they can damage the appliance. Nylon pads can also be unsuitable.
- Take extra care when cleaning over symbols on fascia panels. Excessive cleaning can lead to the symbols fading.
- If your product is fitted with stainless steel cladding strips. You may notice a small white residue on the outer edges, this can be removed with a non abrasive wipe.
- Some foods are corrosive eg; vinegar, fruit juices and especially salt - they can mark or damage the metal or paint work, if they are left on the surface.
- Only use a clean cloth wrung out in hot soapy water, and dry with a soft cloth.

Stainless steel & Aluminium surfaces

- Stubborn marks can be removed using a stainless steel cleaner. Supplies can be purchased from the Customer Care Centre.
- Sharp objects can mark the surface of stainless steel, but will become less noticeable with time.
- Baby oil can be used to restore stainless steel finishes - but only use a few drops. Don't use cooking oils

as they can contain salts, which will damage the metal.

Enamel surfaces & parts

- If larger splashes of fat do not readily disappear, you can use a mild cream cleaner to remove them.

Glass parts

WARNING:- Do not use harsh abrasive cleaners or sharp metal scrapers to clean the oven door glass since they can scratch the surface, which may result in shattering of the glass.

Chrome plated parts

- Use a moist soap filled pad, or place in a dishwasher

CLEANING

REMOVING OVEN PARTS FOR CLEANING

Inner Door Glass (glass doors only)

- The inner door glass panel can be removed for cleaning but it must be replaced the right way up. If there is any writing on the glass, you must be able to read it clearly when the cavity doors are open.
- Always make sure that the glass is pushed fully into the Stop position.
- To remove the glass panel, open the door wide, hold the top and bottom edges and slide out.
- **Warning:** Do not operate the appliance without the glass panel correctly fitted.
- For your safety, glass door panels are made of toughened glass. This ensures that, in the unlikely event that a panel breaks, it does so into small fragments to minimise the risk of injury. Please take care when handling, using or cleaning all glass panels, as any damage to the surfaces or edges may result in the glass breaking without warning or apparent cause at a later date. Should any glass panel be damaged, we strongly recommend

that it is replaced immediately.

Shelf Runners

- Shelf runners can be removed to enable you to clean them thoroughly. Make sure they are cool to touch and then grasp the runners and slide out of their hanging holes.

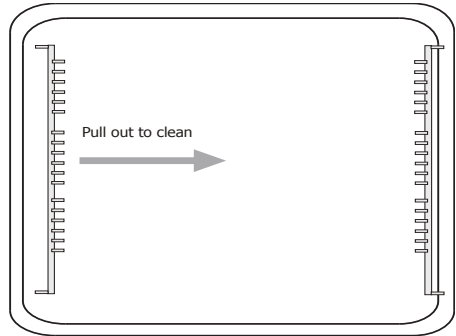

CLEANING

TELESCOPIC SHELVING SYSTEM (if fitted)

- In addition to the traditional shelving fitted in your appliance, the telescopic shelving system is fitted in the most commonly used location in your cavity.
- The shelves with the telescopic system are easier to pull out than traditional shelving, which means the oven door stays open for a shorter period of time. The smooth action also reduces the likelihood of fat, or food, spillage, and gives you extra security.
- You do not have to use the telescopic shelves all of the time. You can place the shelves in the traditional positions if you would like more choice.
- The telescopic shelves remove easily from the runner for re-positioning or cleaning, but we recommend that you reposition your shelving before cooking, and remove the shelving for cleaning when the shelves are cold to prevent burning yourself.

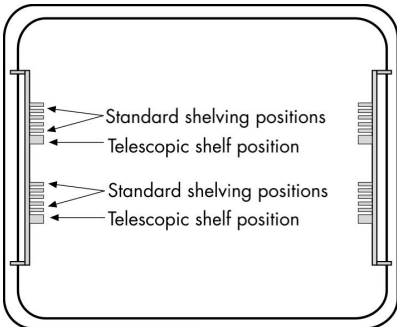

To remove the telescopic shelves

- Make sure the shelf is cool enough to touch.
- Push the oven shelf back into the cavity, until it hits the stop position.
- Grasp the shelf bars in the centre, and lift the back of the shelf clear of the stop position.
- You can then lift the front of the shelf clear of the retaining tabs.

To replace the telescopic shelves

- Make sure the oven runners are pushed all the way back into the cavity.
- Tilt the shelf and make sure the front of the shelf is against the stop position.
- Carefully place the shelf back onto the runner and snap in place firmly.
- Make sure the back of the self is inside the retaining tabs and slide it in and out of the oven to make sure it works correctly.

Make sure the shelf is firmly pressed against the stop position at back of the oven cavity

Note: Make sure the shelf is unclipped from the retaining tabs before removal.

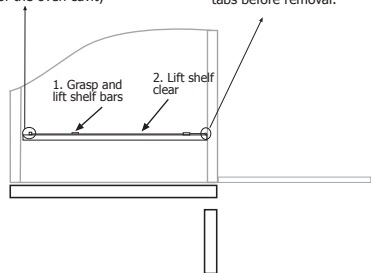

CLEANING

ELECTRIC HOB

Ceramic glass hobs

- The ceramic hob top can be cleaned using a clean, damp cloth or kitchen paper. Do not use a used dishcloth or sponge as they can leave a film of detergent on the surface which can lead to discoloration. Please ensure that the elements are cooled fully to avoid steam burns.
- You can use a specialist ceramic cleaner to restore the surface, but use sparingly to avoid coating the hob top too thickly. Too much cream cleaner will lead to discolouration. Use a dry, clean cloth to polish the surface.
- For stubborn marks, a specialist hob scraper can be used.
- Do not use steam cleaners or high pressure cleaning equipment.
- Regular cleaning will prevent any salts or minerals from accumulating on your hob and discolouring the glass.
- Wipe any spillage as soon as possible.
- Clean the hob top as regularly as possible, this will prevent any build up of grease which may be a fire hazard.

Solid plate hobs

- Prime and Season - this helps maintain the finish of the elements.
- Use a damp, clean cloth to wipe the solid plate, making sure that you follow the circular grooves and avoid damaging the red spots. Make sure that you allow the hotplate to dry before use by switching on the elements at a low heat.

- You can restore the hotplates by using a solid plate cleaner but take care to avoid the red spots on elements.
- To prime: Switch on each element in turn for a short while (with no pan on it) at a medium - high setting. This will harden and burn off the coating.
- To season: Heat the element for 30 seconds at a medium setting then switch off. Use a minimum amount of unsalted vegetable oil, on a dry cloth or paper towel, and apply a thin coat of oil to the element surface. Wipe off the excess and heat the element for one minute.

INSTALLATION INSTRUCTIONS RANGE ELECTRIC

Moving the cooker

Take care if the appliance needs to be lifted during installation - always use an appropriate method of lifting.

Do not attempt to move the cooker by pulling on the doors or handles. Open the door and grasp the frame of the cooker, taking care that the door does not shut on your fingers.

Take care to avoid damage to soft or uneven floor coverings when moving the appliance. Some cushioned vinyl floor coverings may not be designed to withstand sliding appliances without marking or damage.

Important: Ensure that you route all mains cables well clear of any adjacent heat source.

INSTALLATION INSTRUCTIONS RANGE ELECTRIC

Clearances

This cooker may be fitted flush to the base units of your kitchen.

- No shelf, overhang, cupboard, or cooker hood should be less than 650mm above the hob top, but please check this with the hood manufacturers instructions.

- If your appliance has a side opening door, we recommend a side clearance of 60mm to allow the oven door to fully open.
- The cooker must have a side clearance above hob level of 90mm up to a height of 400mm.

The important dimensions are those around the appliance.

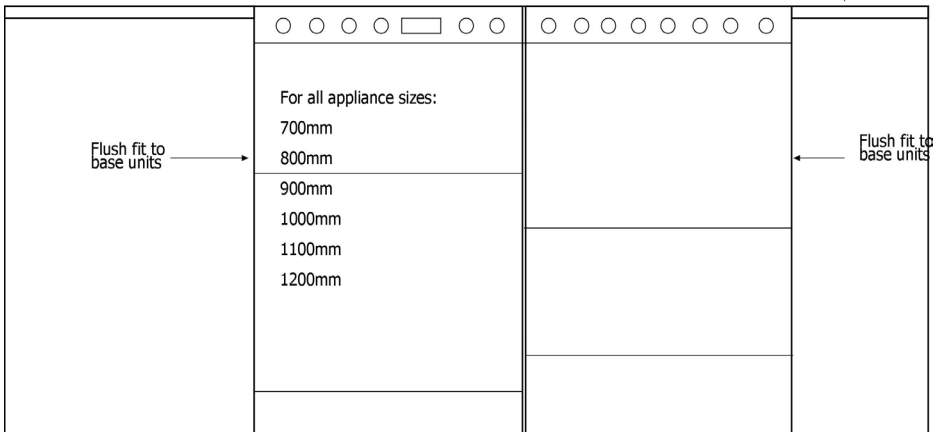
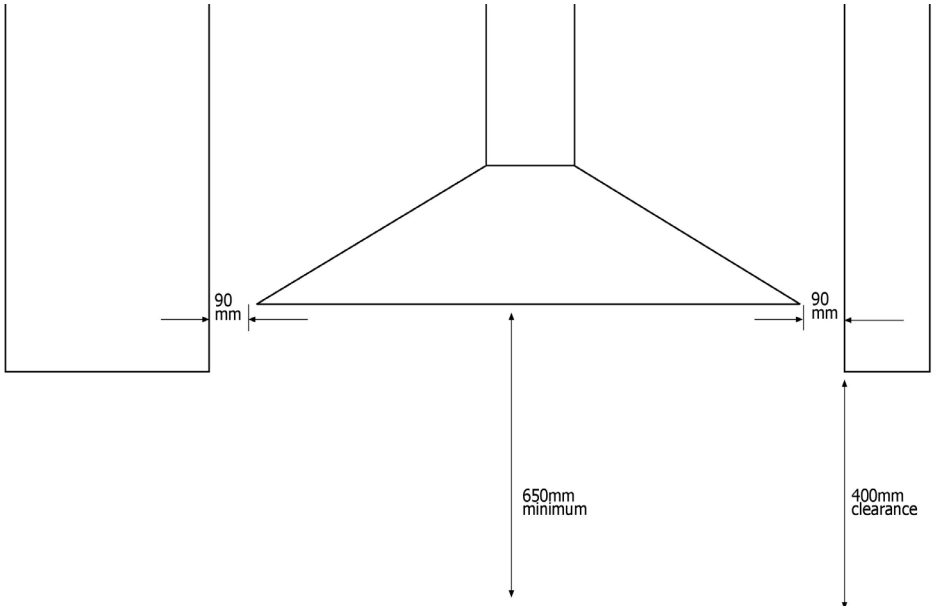

INSTALLATION INSTRUCTIONS RANGE ELECTRIC

Fitting the plinth (if applicable)

- Ensure the appliance is raised to a height of 915mm or above using adjusting feet (A) before beginning.
- Open the appliance doors and loosen screw (C), do not remove the screw entirely. If your appliance has a storage drawer at the bottom, you access these screws through holes located at the base of the drawer after lifting the mat.
- Fit plinth (B) and secure using screw (C).

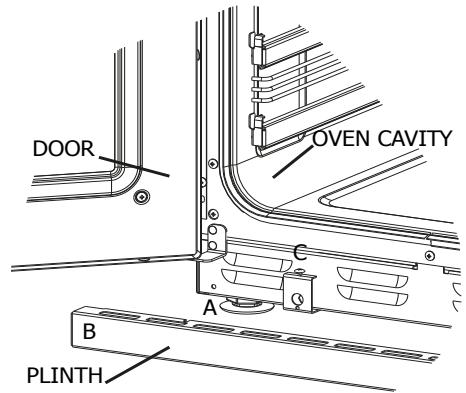

Fitting the splashback (if applicable)

- Loosely fit screw A and nut B into hole 1 at both ends of the rear surface of the appliance.
- Locate fitted screw A through the slots in both of the metal splashback plates.
- Tighten screw A and nut B.
- Now locate and tighten screw C and nut D through hole (2) at both ends of the rear surface of the appliance. Make sure that the splashback is securely attached, but avoid over tightening.

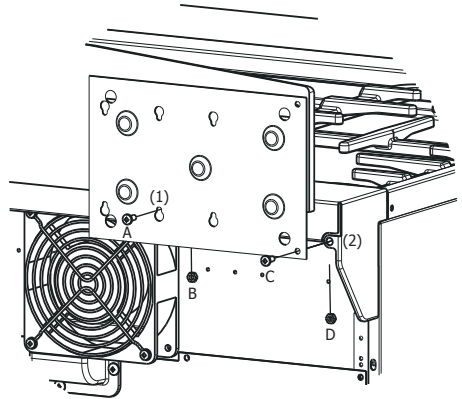

Fitting the towel rail (if applicable)

- On the towel rail there are two holes, top (A) and bottom (B), these holes have corresponding holes on the fascia at each end.
- The screw for the top hole (A), must be screwed into the supplied adaptor, where as the remaining screw just goes through the bottom hole (B). Both screws are M6 screws. Using the allen key provided, tighten the screws making sure that the towel rail is flush to the fascia, but not over tightened.

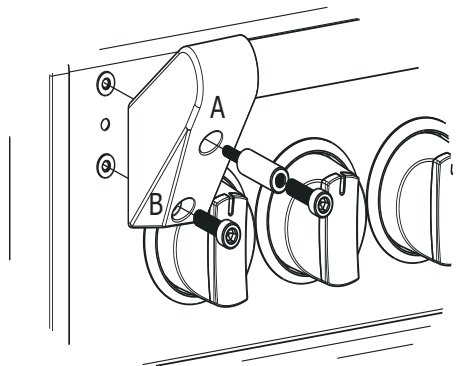

TECHNICAL DATA

Induction Hob	kW Rating @ 240v
Left Front	1.6kW Boost to 3.0kW
Left Back	1.6kW Boost to 3.0kW
Middle	2.3kW Boost to 3.7kW
Right Front	1.1kW Boost to 2.2kW
Right Back	1.4kW Boost to 3.0kW

Appliance	Size	220 - 240 50 Hz (Sterling or Richmond)	
Sterling & Richmond	900	13.74kW - 14.95kW	
Sterling & Richmond	1000	13.47kW - 14.63kW	
Sterling & Richmond	1100	13.55kW - 14.72kW	

Countries of Destination:

GB - great Britain.

IE - Ireland.

CUSTOMER CARE

FAQs

What parts of the appliance can be washed in a dishwasher?

- Any enamelled parts such as the grill-pan can be cleaned in a dishwasher, as can oven shelves and shelf guides.

What parts must NOT be cleaned in a dishwasher?

- Parts such as burner skirts and caps, control knobs and any cast iron items must not be cleaned in a dishwasher, they should be cleaned with hot soapy water and a nylon brush once they are cool enough.

There's been a power failure and the product won't work.

- Switch off the electricity supply.
- When the power returns switch the electricity supply back on and re-set any programmer/clock to the correct time of day.

My oven is a single combined oven and grill - can I use both functions together?

- No. You can only use one or the other.

Why is there condensation on the doors?

- Condensation is caused by hot, moist air meeting a cooler surface (i.e. the oven door). You cannot always prevent it, but you can minimise it when it happens by doing the following:
- Pre-heat the oven at a high temperature before putting food in the oven, and cover the food you are cooking wherever possible.
- Whenever you can, cook wet foods at higher temperatures.
- Don't leave food in the oven to cool down.
- Automatic cooking will normally produce condensation when the oven is cooling down with food inside.

Why is there steam or smoke escaping from the oven?

- Your oven is fitted with a steam vent at the top of the main oven. This is to allow excessive steam out of the oven whilst cooking wet foods such as quiche or pizza.
- If your main oven smokes during its use, it is important that the oven cavity is kept clean and not contaminated with grease or old foods.

Should the cooling fan continue to run once the appliance has been switched off?

- Yes. Your oven is fitted with a cooling fan to keep the operator controls cool. In some cases the cooling fan may continue to run even after the oven is switched off to disperse the residual heat of the oven.

What is a Multifunction oven?

- A multifunction oven combines a variety of features, which are explained fully earlier in this book (if fitted), it allows you more flexibility when cooking.

The neon on my appliance keeps going out and coming back on again.

- Yes. In most cases the neon (if fitted) will cycle on and off to show that oven is maintaining your temperature choice.

My new oven is giving off a strange smell?

- This is the smell of the oven being used for the first time. After a small period of uses, the smell will deteriorate. Whilst inside the oven your food will never be polluted by this smell.

Call Customer Care for a Service Engineer's visit if:

- You find that the oven becomes hotter at a particular temperature - the thermostat may need replacing.
- The cooling fan fails to work.

CUSTOMER CARE

CUSTOMER CARE WEB SHOP

Having purchased a superior cooker, hob or hood from us, you'll naturally want to keep it looking great. And who better to help you care for it than the manufacturer?

We offer an extensive range of accessories, components and cleaning products which, will instantly give your cooker a good as new look.

In addition to the list of our most popular products below, we also have an exciting

range of Bake ware and Cookware essentials including Roasting Pans, Cake Tins and Non-Stick Cooking Liners.

For all enquires, please visit our Web Shop at www.gdhaonline.co.uk or call the Spares Sales Team on **0844 815 3745**. For countries outside the UK, please contact your local service agent.

Product Description	Where used	Purpose
Ceramic Hob Cleaner	All Ceramic glass hobs including Induction	Enables easier cleaning of your ceramic hob. Prevents build up of mineral deposits. Best used with Ceramic Hob Scraper Kit. 300ml bottle.
Ceramic Hob Scraper kit	All Ceramic glass hobs including Induction	Ideal for removing cooked on marks from ceramic glass hobs Best used with Ceramic Hob Cleaner
Sealed Hotplate Conditioner	All sealed/solid plate hobs	Restores the sleek matt black finish to solid hotplates
Multipurpose Kitchen Cleaner	General kitchen cleaner	Excellent multipurpose cleaner, For use around the kitchen. 500ml bottle.
Oven Cleaner	All cooking appliances.	Cuts through grease & burnt on grime. 500ml bottle
Restor-A-Cloth	All cooking appliances.	Chemical free cleaning cloth Ideal for cleaning & polishing glass & stainless steel
Stainless Steel Cleaner	All stainless steel parts	Oil based cleaner. Perfect for removing stubborn & greasy marks. 300ml bottle.
Rectangular carbon filters	Cooker Hoods	New filters, help to maintain efficient cooker hood operation and keep your Kitchen odour free
Round Carbon Filters	Cooker Hoods	New filters, help to maintain efficient cooker hood operation and keep your Kitchen odour free

CUSTOMER CARE

CHANGING LIGHT BULBS (where fitted)

Warning: There is a risk of electric shock, so always make sure you have turned off and unplugged your appliance before starting. Always allow the product to cool down before you change a bulb.

Not all appliances have the same number and type of bulbs. Before replacing your bulb, open the oven door and see which type you have. Then use the table to help you change your bulb correctly.

Bulbs can be purchased from hardwarestores (always take the old bulb with you).

Please remember that bulbs are not covered by your warranty.

No of Lamps	Instructions
1	Remove the oven shelves. Remove the loose oven back by unscrewing the 4 securing screws (one at each corner) and remove (Where fitted). Unscrew the lens cover by turning anticlockwise. Remove the bulb and replace. Replace the lens cover and oven back.

CUSTOMER CARE

To contact Stoves about your appliance, please call

Warranty Registration

0844 481 0182

to register your appliance

Customer Care Helpline

0844 815 3740

in case of difficulty within the UK

Alternatively general, spares and service information is available from our website at
www.stoves.co.uk

Please ensure that you have the product's model no and serial no available when you call. These can be found on the silver data label on your product which is located:

Ovens	Open the door; adjacent to the oven cavity
High-level grill products	Inside the base compartment
Hobs	On the underside of the product

Enter appliance numbers here for future reference:

Model No

--	--	--	--	--	--	--	--	--	--

Serial No

--	--	--	--	--	--	--	--	--	--

SERVICE RECORD

Date of purchase	Installed by	Installation Date
Place of purchase:		

Date	Part(s) replaced	Engineer's name

For customers outside the UK and Northern Ireland, please contact your local supplier.

Glen Dimplex Home Appliances, Stoney Lane, Prescot, Merseyside, L35 2XW